

MATHEMATICS

(ENGLISH MEDIUM)

Class - IV

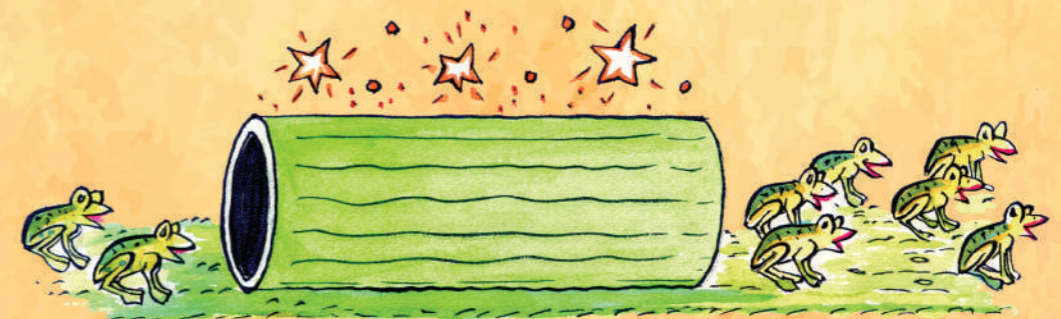
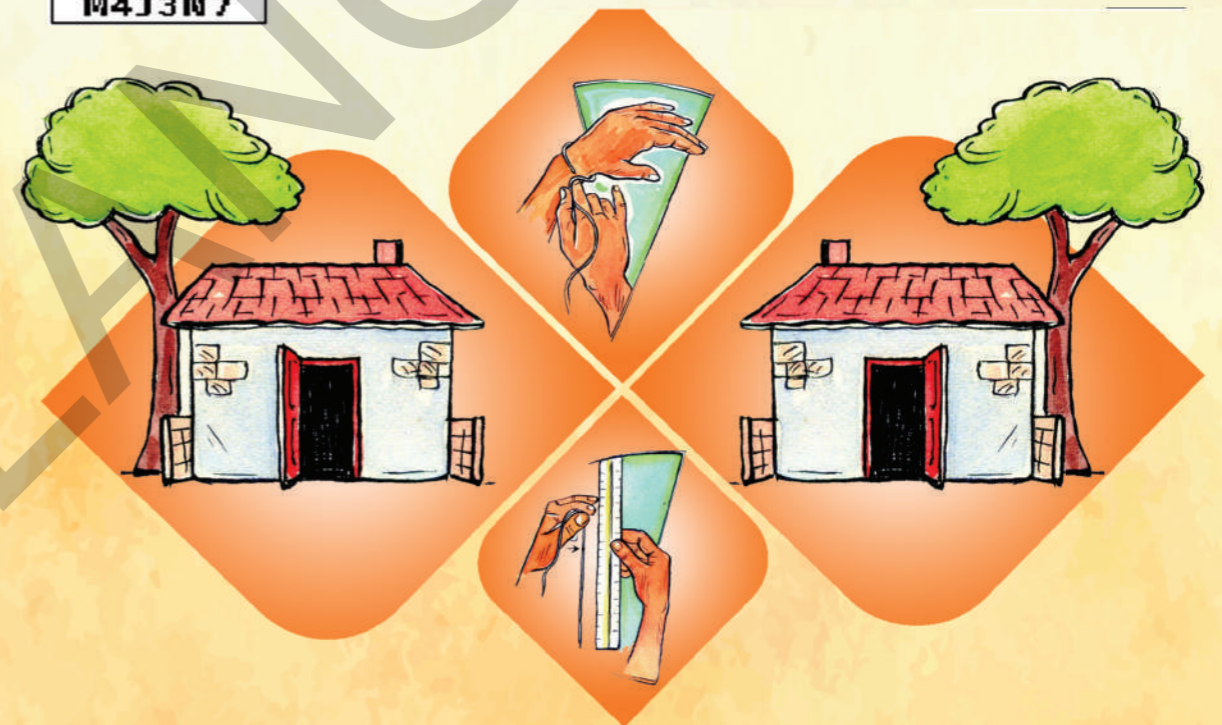

State Council of Educational Research and Training
Telangana, Hyderabad



Published by
Government of Telangana, Hyderabad

Government's Gift for Students' Progress

Government's Gift for Students' Progress

MATHEMATICS

CLASS - IV



Published by

The Government of Telangana, Hyderabad

**Respect the Law
Get the Rights**

**Grow by Education
Behave Humbly**



© Government of Telangana, Hyderabad.

First Published 2013

New Impressions 2014, 2015, 2016, 2017, 2018, 2019, 2020, 2021, 2022, 2023

All rights reserved.

No part of this publication may be reproduced, stored in a retrieval system, or transmitted, in any form or by any means without the prior permission in writing of the publisher, nor be otherwise circulated in any form of binding or cover other than that in which it is published and without a similar condition including this condition being imposed on the subsequent purchaser.

The copy right holder of this book is the Director of School Education, Hyderabad, Telangana.

This Book has been printed on 90 G.S.M. Maplitho
Title Page 250 G.S.M. White Art Card

Government's Gift for Students' Progress – 2023-24

Printed in India
at the Telangana Govt. Text Book Press,
Mint Compound, Hyderabad,
Telangana.

— o —

FORE WORD

Mathematics is a part of every child's daily life. A child who is helping her parents in the kitchen or in the field or is even playing with her friends is constantly engaging with mathematical problems of various types. So, far from knowing 'no mathematics' a child who starts coming to school brings with herself a variety of experiences about numbers and space, often much richer than any one of us appreciate.

Children also have immense potential to learn and more importantly all children are capable of learning mathematics. Their curiosity about the world and the need to understand it complements their capability. Children's innate abilities for mathematics such as those for classification, matching, estimation, analysis, mapping, generalization etc., along with their experiences of quantity and space are aids to classroom teaching which all of us as teachers should utilize during classroom time.

It is also important to appreciate that while Mathematics learns from human experiences, its growth and progression is not dependent on them; but it relies on the logic and creativity of the human mind. So, the goal of teaching mathematics goes beyond developing 'useful' numeracy capabilities. The ability to reason mathematically and handle abstraction are central to mathematics learning. Learning mathematics also should not be equated to learning only numbers and spatial visualizations, patterns etc. They are integral part of mathematical knowledge that children should be asked to engage with.

The aforesaid vision of mathematics teaching presented in State Curriculum Framework (SCF)-2011 has been elaborated in its Mathematics Position Paper which also clearly lays down the Academic Standards of teaching mathematics in the State. The textbooks make an attempt to concretize all these sentiments discussed in these documents. Concepts are placed in meaningful contexts and they are also arrived at by observing patterns, and providing children opportunities to state them in their own words. Use of definitions and irrelevant terminology has been avoided. Multiple ways in which children can solve a problem are encouraged and various attempts have also been made to help children understand the algorithm than engage with it mechanically. Problem posing is an important part of mathematics and children have been encouraged to create a variety of problems. Space has been provided for both individual work and collaborative learning. Pictures have been used thoughtfully to aid both concept building and also act as fillers to encourage different ideas such as collaborative learning. The book is designed in colour to add to a child's interest.

The State Council for Education, Research and Training, Telangana appreciates the hard work of the textbook development committee. Several teachers from all over Andhra Pradesh have contributed to the development of this textbook. We are grateful to the district education officers, mandal education officers and head teachers for making this possible. We also thank the institutions and organizations which have given their time in the development of this textbook. We are grateful to the office of the Commissioner Director- School Education for extending its co-operation in developing this textbook. In the endeavor to continuously improve the quality of our work, we welcome your comments and suggestions on this book.

Our special thanks to Room to Read India Trust, Hyderabad for their technical support in redesigning of the textbooks.

**Director,
SCERT, Hyderabad**

NATIONAL ANTHEM

Jana-gana-mana-adhinayaka, jaya he

Bharata-bhagya-vidhata.

Punjab-Sindh-Gujarat-Maratha

Dravida-Utkala-Banga

Vindhya-Himachala-Yamuna-Ganga

Uchchhala-jaladhi-taranga.

Tava shubha name jage,

Tava shubha asisa mage,

Gahe tava jaya gatha,

Jana-gana-mangala-dayaka jaya he

Bharata-bhagya-vidhata.

Jaya he! jaya he! jaya he!

Jaya jaya jaya, jaya he!!

- *Rabindranath Tagore*

PLEDGE

“India is my country. All Indians are my brothers and sisters.

I love my country, and I am proud of its rich and varied heritage. I shall always strive to be worthy of it.

I shall give my parents, teachers and all elders respect, and treat everyone with courtesy. I shall be kind to animals.

To my country and my people, I pledge my devotion. In their well-being and prosperity alone lies my happiness.”

- *Pydimarri Venkata Subba Rao*

CONTENTS

<i>S. No.</i>	<i>Contents</i>	<i>Syllabus to be covered during</i>	<i>Page No.</i>
1.	<i>Many objects - Different shapes</i>	<i>June</i>	<i>1-7</i>
2.	<i>Different views - Different sides</i>	<i>June</i>	<i>8-14</i>
3.	<i>Some more shapes</i>	<i>July</i>	<i>15-22</i>
4.	<i>Knowing numbers</i>	<i>July</i>	<i>23-37</i>
5.	<i>How much more - How much less?</i>	<i>August</i>	<i>38-48</i>
6.	<i>How many times?</i>	<i>August</i>	<i>49-60</i>
7.	<i>Equal shares and equal groups</i>	<i>September</i>	<i>61-70</i>
8.	<i>How long is this?</i>	<i>September</i>	<i>71-79</i>
9.	<i>How much does it weigh?</i>	<i>October</i>	<i>80-90</i>
10.	<i>How much do these bottles hold?</i>	<i>November</i>	<i>91-98</i>
11.	<i>Tick-Tock goes the clock</i>	<i>November</i>	<i>99-107</i>
12.	<i>Dividing into equal parts</i>	<i>December</i>	<i>108-117</i>
13.	<i>Smart tables</i>	<i>December</i>	<i>118-124</i>
14.	<i>Borders and boundaries</i>	<i>January</i>	<i>125-129</i>
15.	<i>Halves that look alike</i>	<i>January</i>	<i>130-133</i>
16.	<i>Patterns</i>	<i>February</i>	<i>134-140</i>
17.	<i>Maths around us</i>	<i>February</i>	<i>141-146</i>
	<i>Revision</i>	<i>March</i>	



THE CONSTITUTION OF INDIA

Preamble

WE, THE PEOPLE OF INDIA, having solemnly resolved to constitute India into a SOVEREIGN SOCIALIST SECULAR DEMOCRATIC REPUBLIC and to secure to all its citizens:

JUSTICE, social, economic and political;

LIBERTY of thought, expression, belief, faith and worship;

EQUALITY of status and of opportunity; and to promote among them all

FRATERNITY assuring the dignity of the individual and the unity and integrity of the Nation;

IN OUR CONSTITUENT ASSEMBLY this twenty-sixth day of November, 1949 do HEREBY ADOPT, ENACT AND GIVE TO OURSELVES THIS CONSTITUTION.

1 Many objects - Different shapes

Today, the teacher is showing objects of various shapes to children in class 4.



Categorize the objects shown based on their shapes. Also, extend this list based on objects you see around you.

Ball -like	Brick-like	Dice-like	Joker hat-like	Drum-like

Think and Discuss

1. Do we roll them or slide them?

- (a) Does a ball roll? Do all ball-shaped objects roll?
- (b) How many ways can we move a suitcase from one place to another? Can we roll it for moving it from one place to another?
- (c) Can objects with a drum-like shape be rolled? Can they also slide?
- (d) Why some objects can only be rolled? Why some objects only be slided? Why some objects can be rolled and slided?

Activity

Nithya and her 5 friends are playing a game. They blind-folded Pallavi and asked her to clap as long as she wished while the others ran around a table. The moment Pallavi stopped clapping everybody should stop wherever they are. Those who are not at the corners of the table would be out.

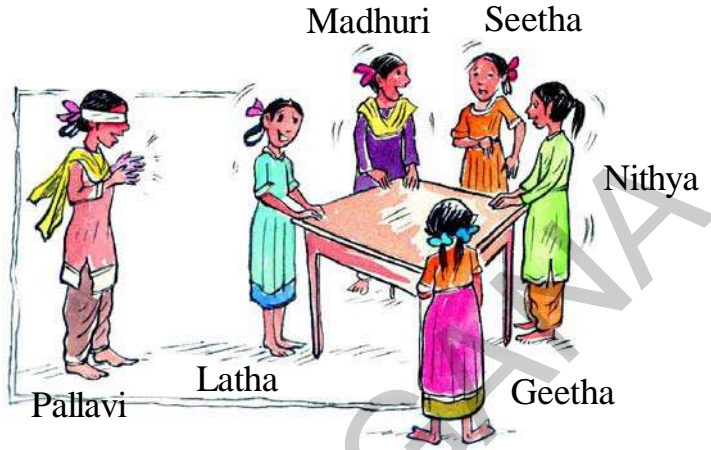

Who is standing at the corners of the table? Who is out of this game? Why?

Now let us count the edges and corners of different shaped objects.

1. How many edges do the below given brick-shaped objects have? How many corners do they have?

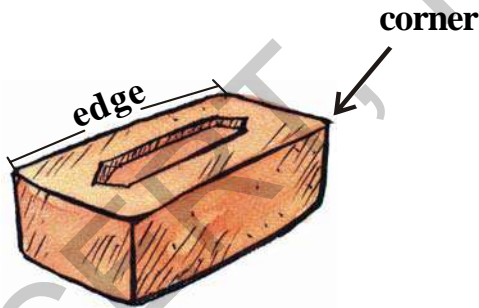

Number of edges _____

Number of corners _____

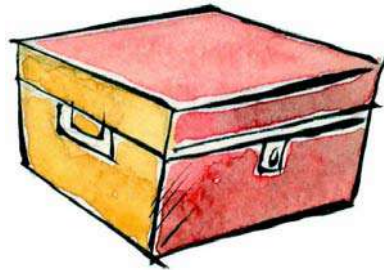

Number of edges _____

Number of corners _____

Note for Teacher : Before undertaking this activity, introduce objects of various shapes to children and help them to recognise and count their edges and corners.

2. How many edges do dice-shaped objects have? How many corners do they have?

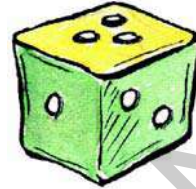

Number of edges _____

Number of edges _____

Number of corners _____

Number of corners _____

3. How many edges do joker hat-shaped objects have? How many corners do they have?

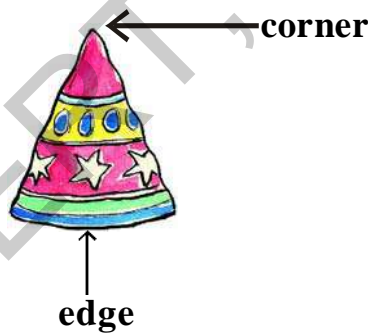

Number of edges _____

Number of edges _____

Number of corners _____

Number of corners _____

4. How many edges do drum-shaped objects have? How many corners do they have?

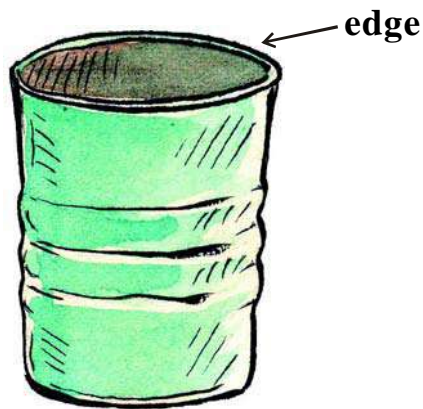

Number of edges _____

Number of edges _____

Number of corners _____

Number of corners _____

5. Do ball-shaped objects have edges and corners? _____

Think and discuss

Why do you think that only ball and drum-shaped objects roll?

Boxes of various types

Take a soap box, put it on a paper and trace all its faces using a pencil as shown below.

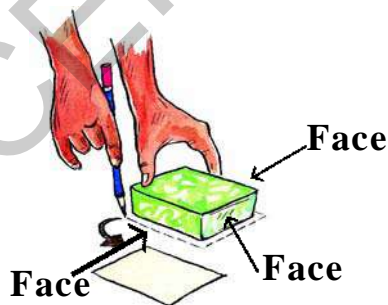

(a) How many faces does a soap-box have? _____

(b) Do all the faces look alike? _____

- (c) Now open the soap box carefully along its edges. Does it look like the picture given below?

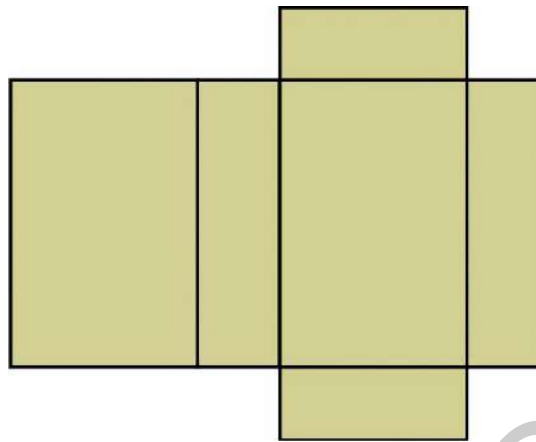

This is called the net form of the soap box.

- (d) Which of these net forms this toothpaste box open into?

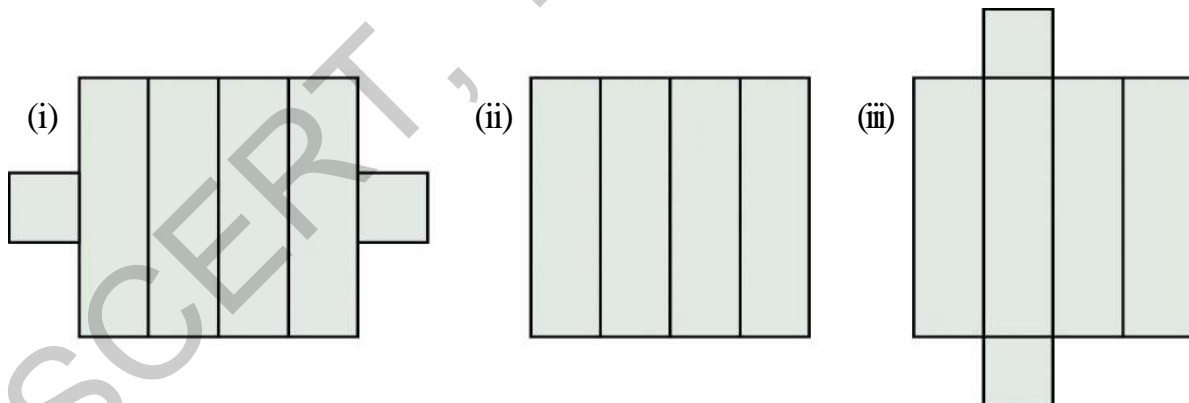

Do These

1. Collect various objects like tooth paste box, sweet box, shoe box etc and open them. Then draw their net forms in your notebook.



Lets play with a dice.

Take a dice and put it on a paper and trace all its faces as shown in the figure.



- (a) How many faces does a dice have? _____
- (b) Do all the faces look alike? _____

Some open boxes

Which of the following net forms can be used to make the given box?

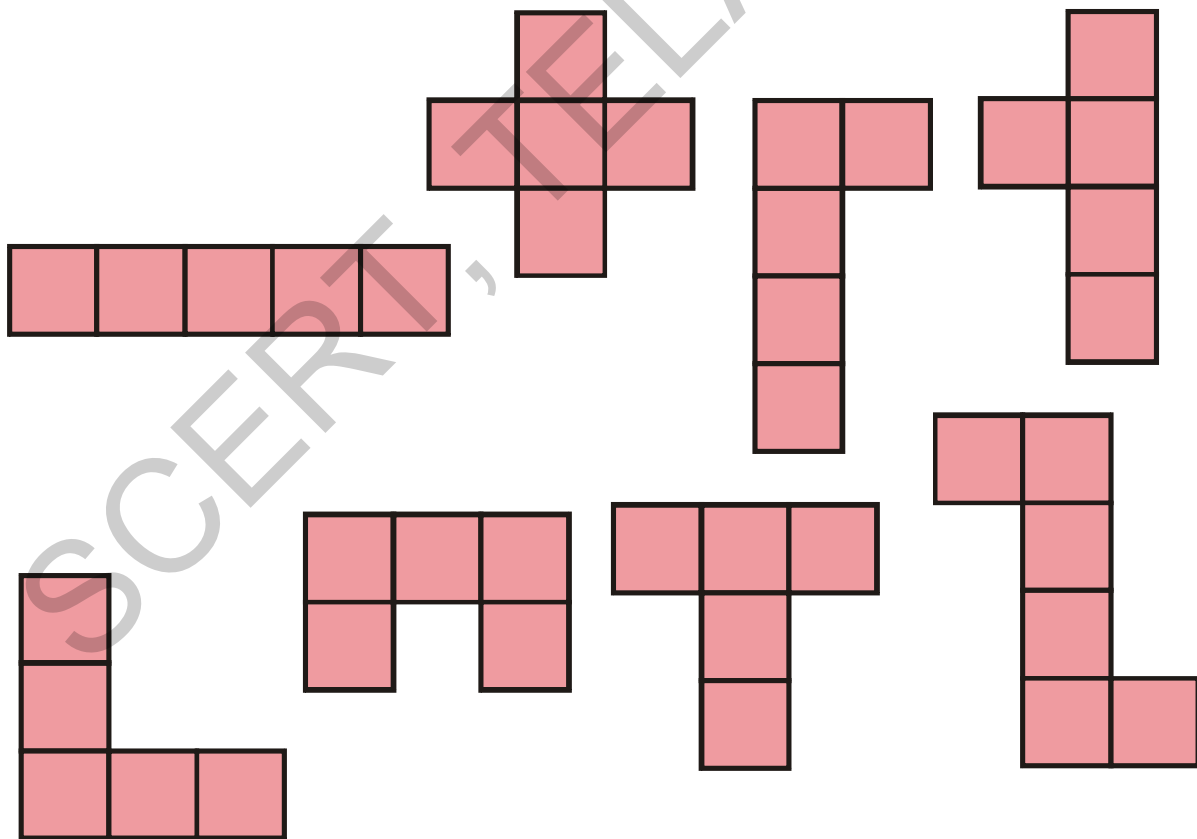
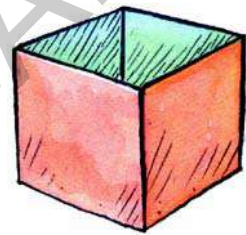

2 Different views - Different sides

Nithya, Meghana, Madhu all have drawn pictures of the same bus but each of them looks different. Think, why do they look different?



Nithya



Madhu

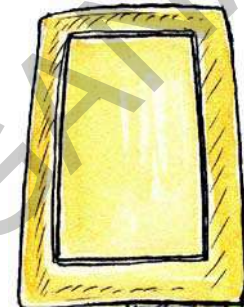

Meghana

- Whose picture represents the front view of the bus?
- Whose picture represents the top view of the bus?
- Whose picture represents the side view of the bus?

Try This

- Go into your kitchen and find out how the following objects look from top.

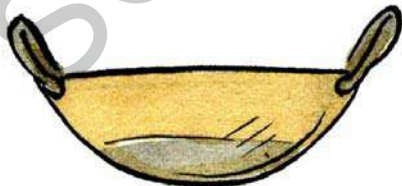

Which shape do they resemble?

Do These

1. Given below are pictures of some more objects. Write 'T' against the pictures which present the top view of the object, write 'S' against the pictures which present the side view.



Which side the photograph has been taken from?

Given below are three pictures of a location. Identify the picture that is taken from the front, that is taken from the back and that from the side and write in the box given.

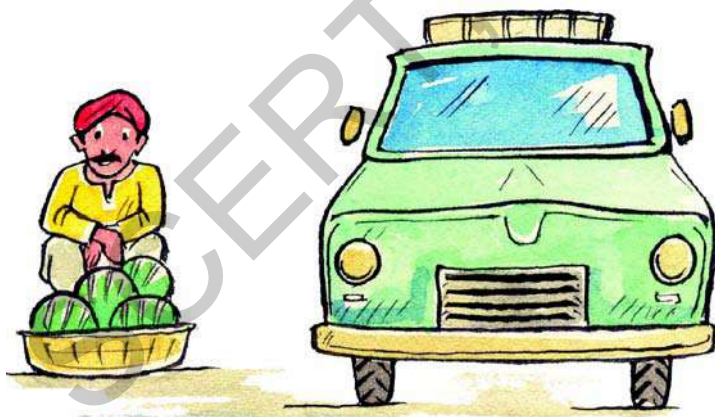



Mittu and Meena's journey



Mittu and Meena were sitting on the fan of this classroom.

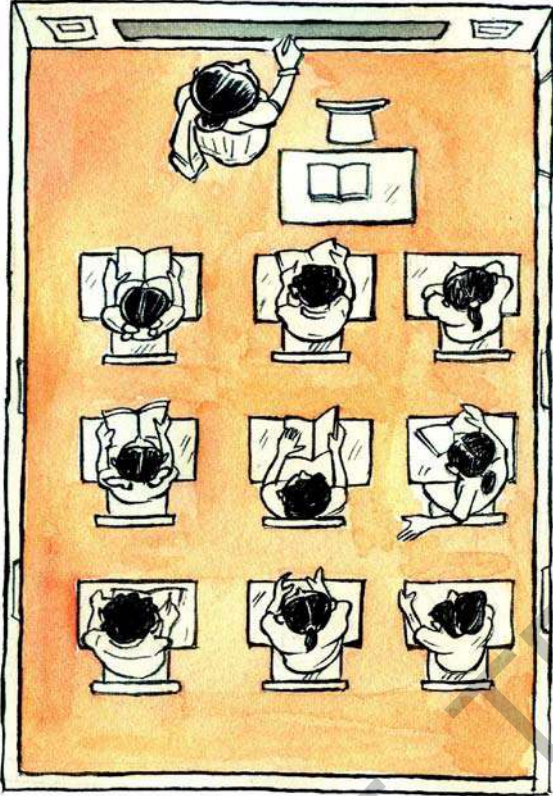

- How many children do they see?
- What is the teacher doing?
- What is there on the teacher's table?
- How many children have opened books on their table?
- Can you draw a book on the teacher's chair?

Try This

- How would your classroom look from the top? Try to draw its picture.

Mittu and Meena flew away from the school and started crossing the fields. They looked down and saw this view.

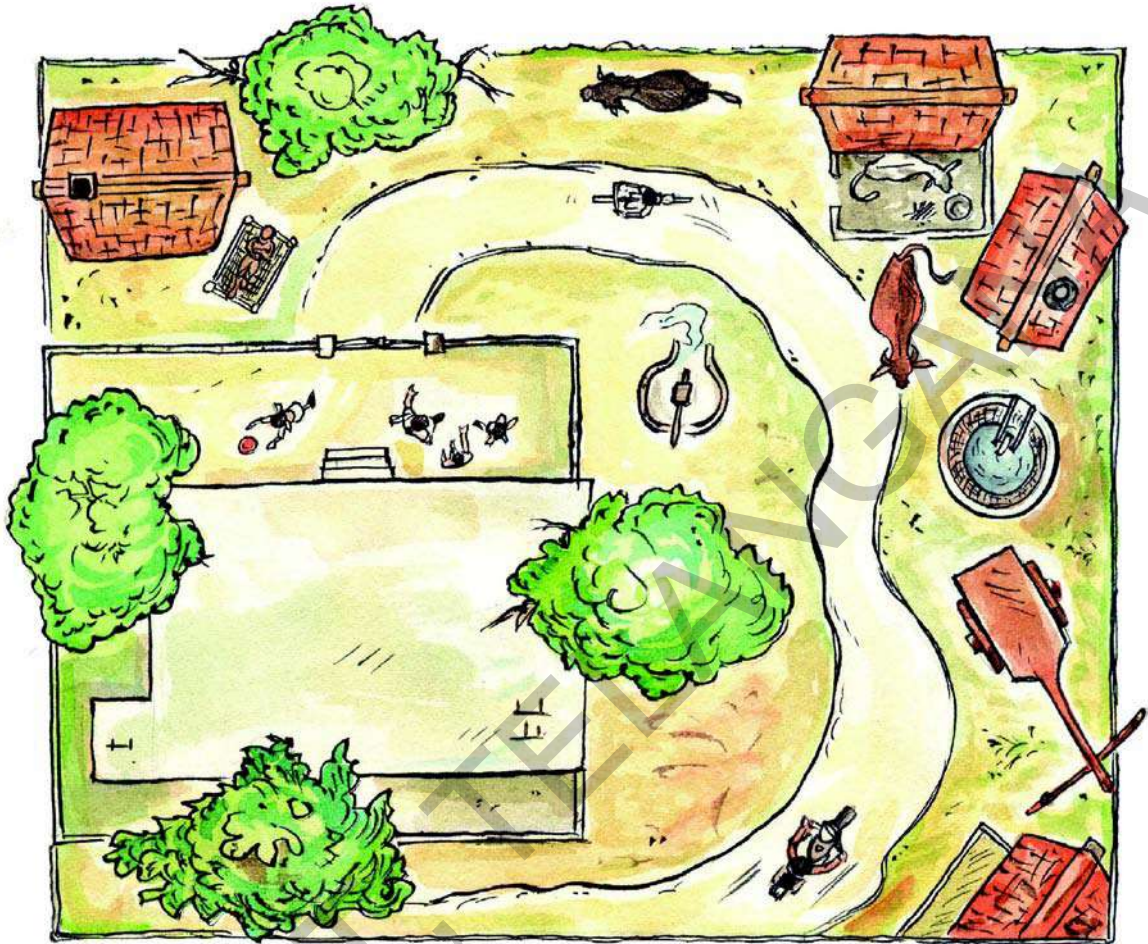

- How many huts are there around the school? _____ What shape do they look like from top? _____
- How many trees are there? _____
- How many vehicles are there on the road? _____ Guess what they could be? _____
- How many animals can you see? _____
- How many round shaped objects do you see? _____
- What are the other things that you can see in the picture? Discuss with your friends.

Now, Mittu and Meena are flying over another place. Guess from where they are flying?

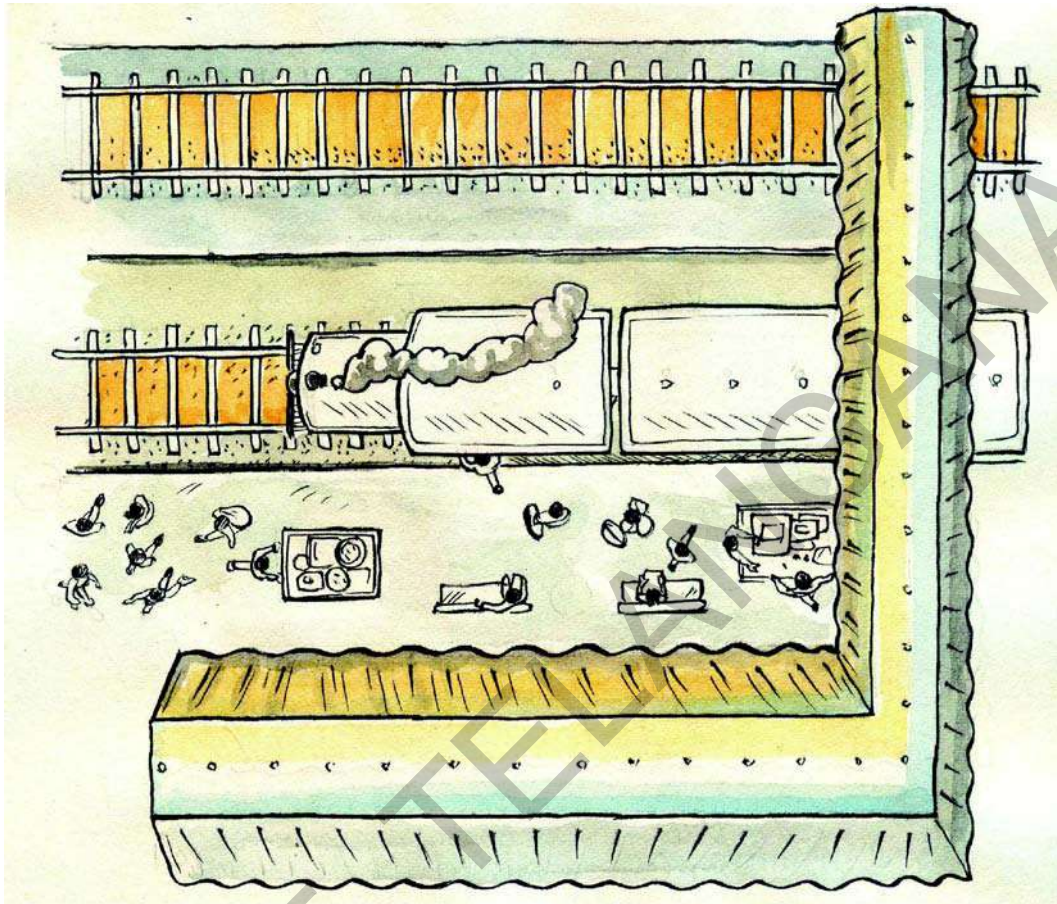

(a) How many railway tracks do you see? _____

(b) How many tracks the train is on? _____

(c) What are the other things that you can see on the platform? Discuss with your friends and write.

(d) When we stand on a railway track the track looks like this, why does the railway track look broader on one side and narrower on the other?

(e) Where else have you noticed such things?

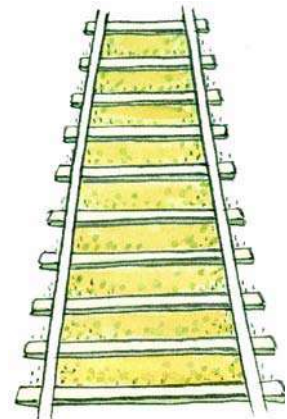

One box on top of the other

1. Look carefully. There are four boxes here.

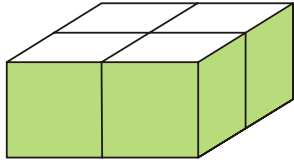

2. How many boxes are there in each picture given below?

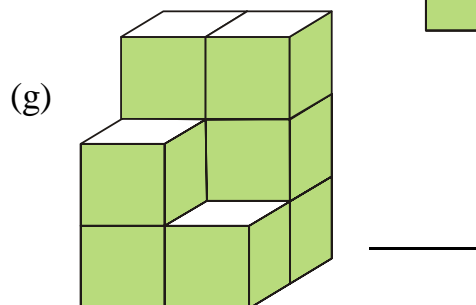
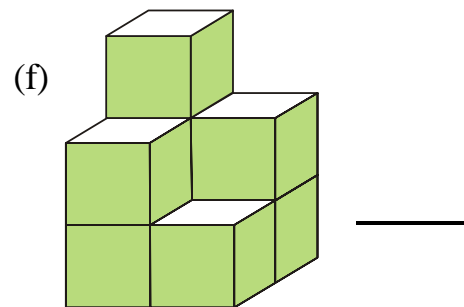
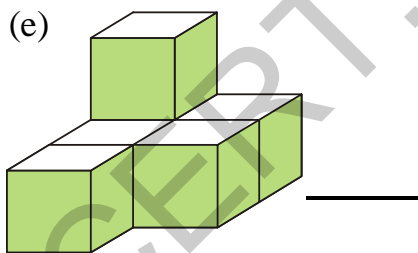
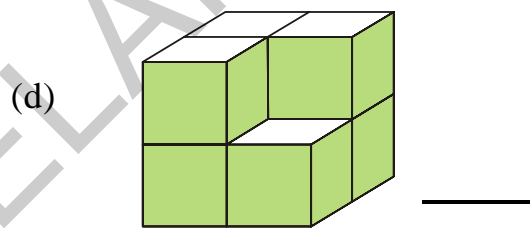
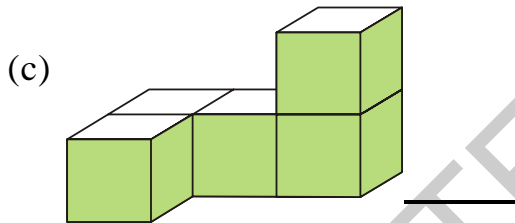
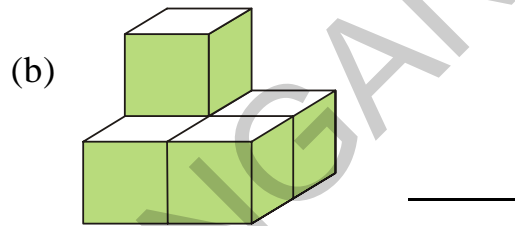
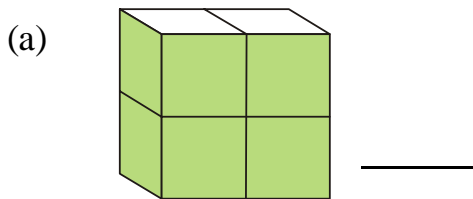

3

Some more shapes



What shapes do you see in this classroom?

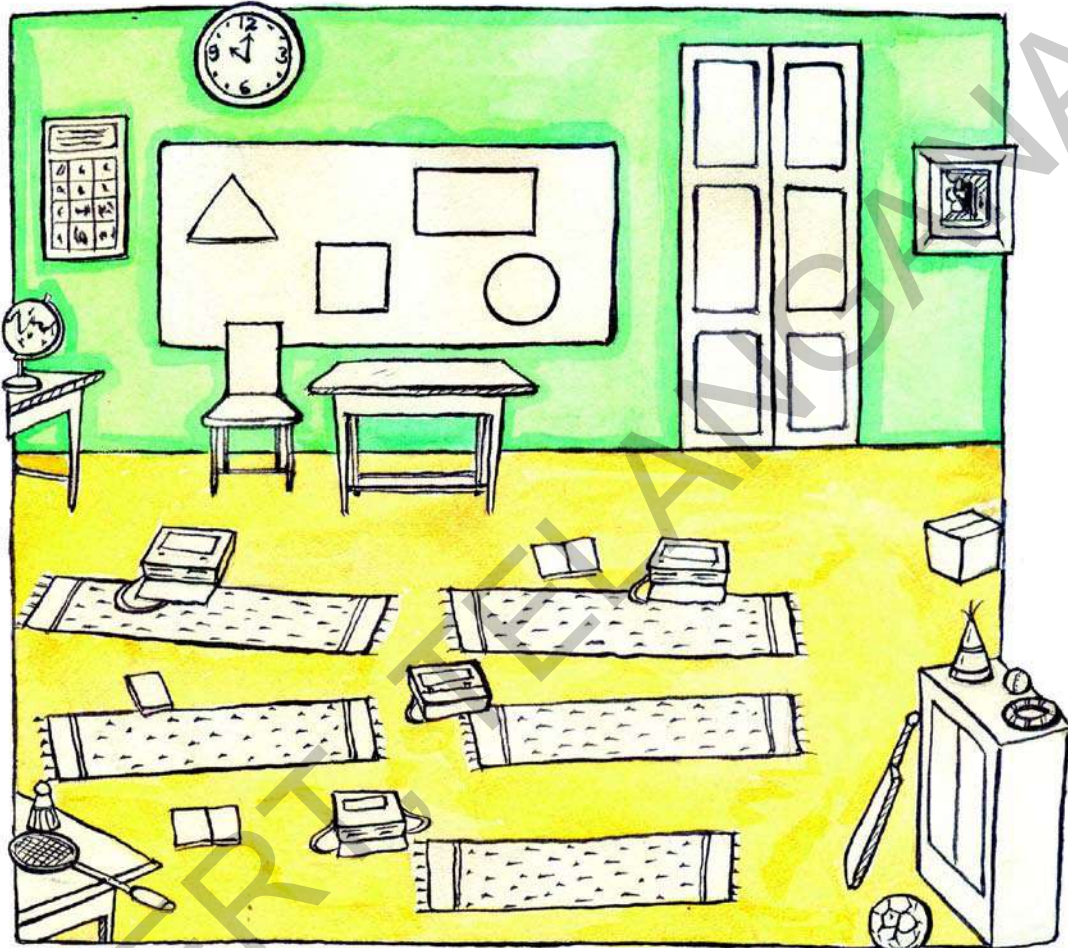

shaped objects : _____

shaped objects : _____

shaped objects : _____

shaped objects : _____

What are these shapes called?

Rectangle

We have already traced the faces of a soap-box as shown in the picture.



They look like this

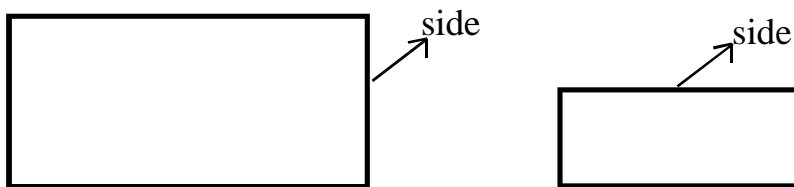

Both the above shapes are called as rectangles.

- (a) How many sides do rectangles have?
- (b) How many corners do rectangles have?
- (c) Are all the sides of a rectangle equal?

Square

You have also drawn the faces of a dice as shown in the picture.

They look like this

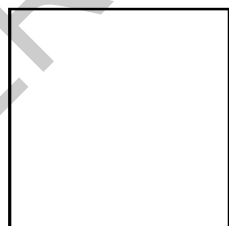

This shape is called as square.

- (a) How many sides does a square have?
- (b) How many corners does it have?
- (c) Are all the sides of a square equal?

Do These

1. Identify the rectangle and square shaped objects in your classroom. Write in the table.

Rectangles	Squares

Triangles

Take a square shaped paper.

Fold it as shown in the figure.

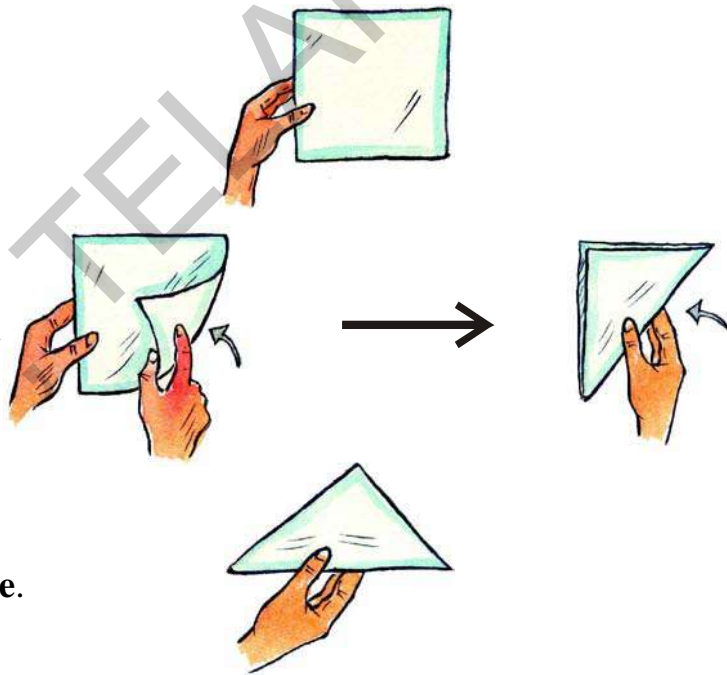

This shape is called a **triangle**.

- (a) How many sides does the triangle have? _____
- (b) How many corners does the triangle have? _____

Do These

1. Which objects around you are in triangular shape? Write them below.

Think and discuss

1. Identify the triangles from the figures given below.

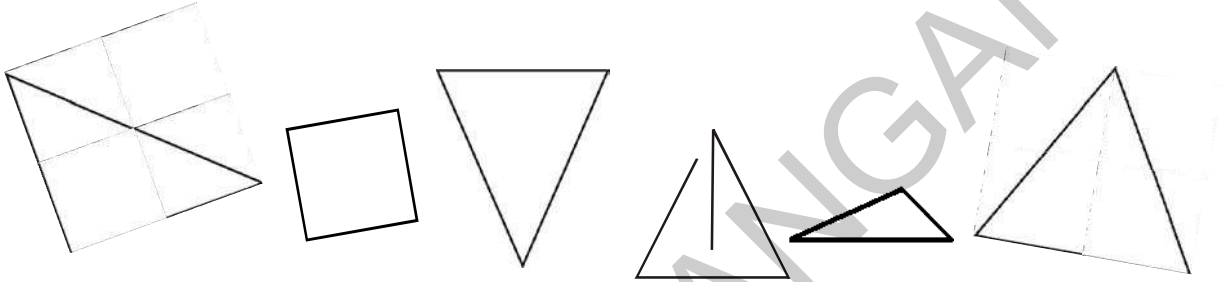

Circle

Latha used her bangle and her mother's bangle and traced the following shapes-

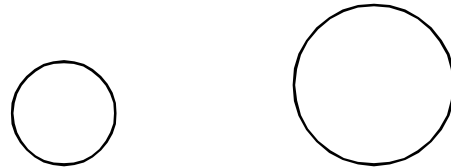

These shapes are called circles.

- (a) Do these shapes have any sides or corners? _____

Do These

Which things around you are circular in shape?

Lets draw pictures using various shapes

Use □, ○, ▭, △, / shapes to make atleast 50 pictures. In each picture you make, you can use any shape as many times as you want and in whichever size you want.

Some examples have been drawn for you.

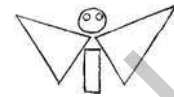
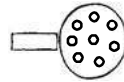
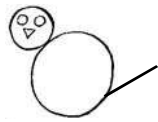

If the space given below is not enough use your notebook to draw.



Can you draw shapes using these dots?

Make squares, rectangles and triangles of different sizes by joining the dots given below. Two shapes have been drawn for you.

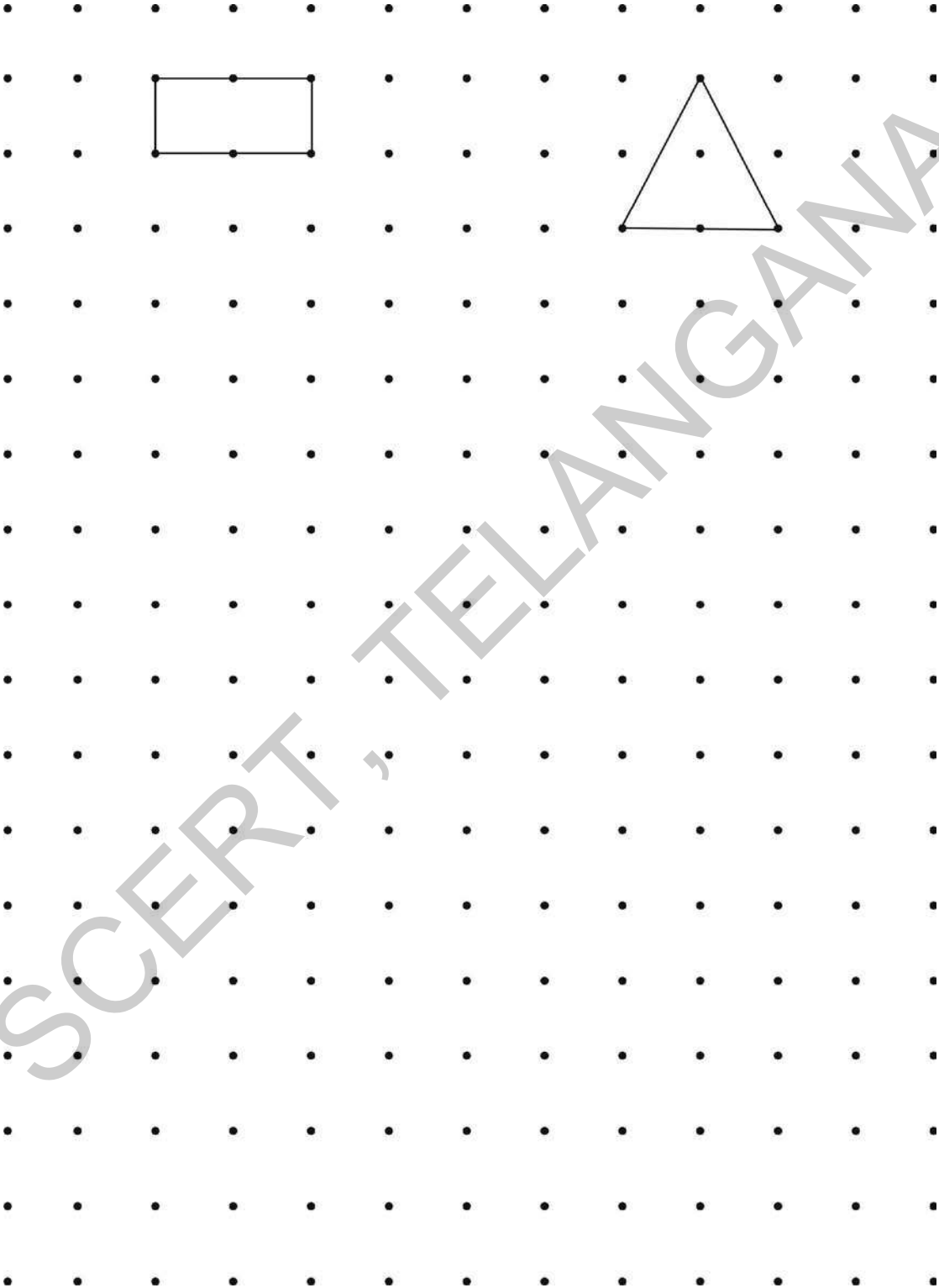

Fill the rangoli with the colours mentioned below.

Green-square, red-circle, yellow-triangle, blue-rectangle.

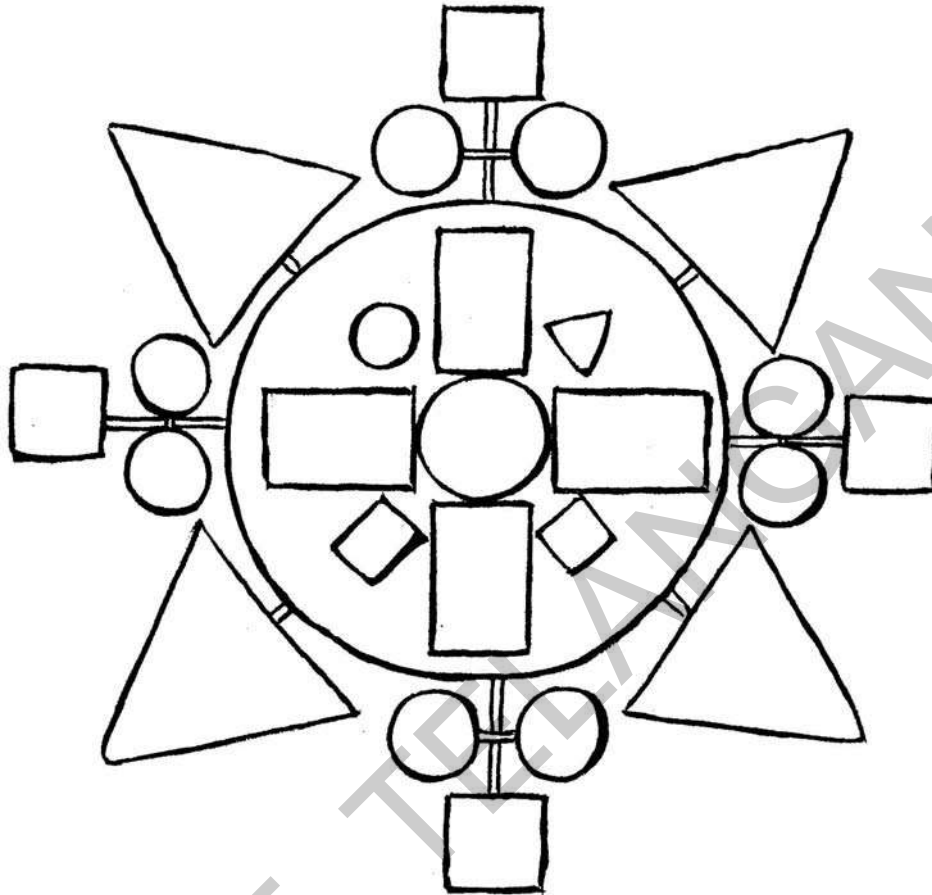

- (a) How many squares do you see? _____
- (b) How many rectangles do you see? _____
- (c) How many circles do you see? _____
- (d) How many triangles do you see? _____

Try This

1. Make your own rangoli using above shapes. Use different colours for different shapes.

Exercise



1. Write the name of the shape formed by tracing the following objects.

- (a) Match box : _____
- (b) Ring ball : _____
- (c) Vicks lozenge : _____
- (d) Text book : _____
- (e) Duster : _____

2. Look at the pictures given below. Count and write the number of each shape in them.

- (a) Number of squares _____
- Number of triangles _____
- Number of rectangles _____

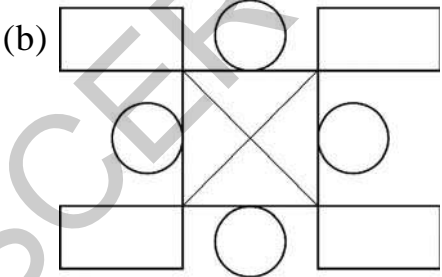
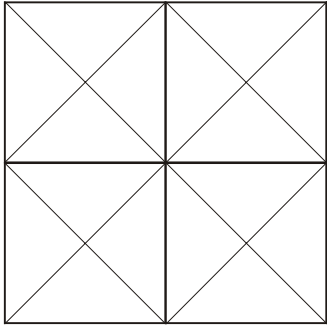

- Number of squares _____
- Number of triangles _____
- Number of rectangles _____
- Number of circles _____

3. Mould clay into squares, rectangles, triangles and circles of different sizes.

4



Knowing numbers

Rama teacher exhibited a chain of beads in the class. After how many beads the colour of the beads in the chain changes? Teacher tied a tag after 10 beads and another after 25 beads as shown in the figure given below. Can you now tie a tag after 50 beads, another after 75 beads and another after 100 beads?

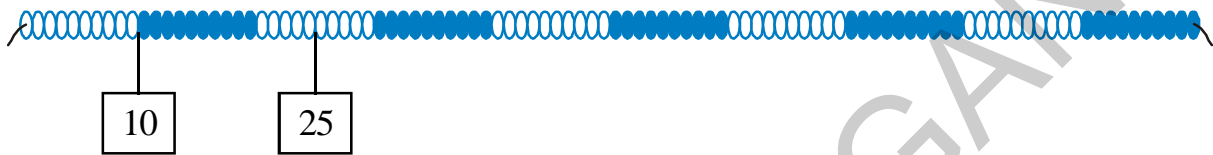

Now identify the numbers and write them on the tags that are hanging on the beads chain given below.

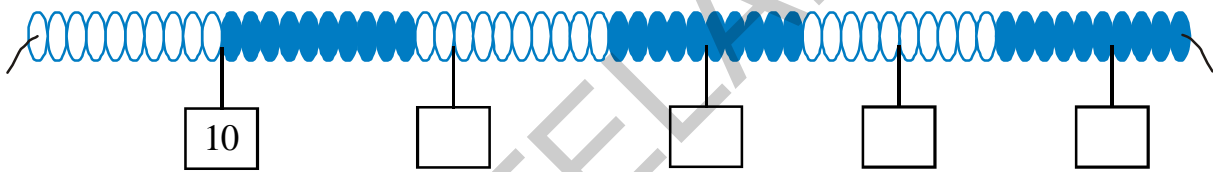

Now tie the tags of 27, 39, 45, 14 on the given beads chain at appropriate place.

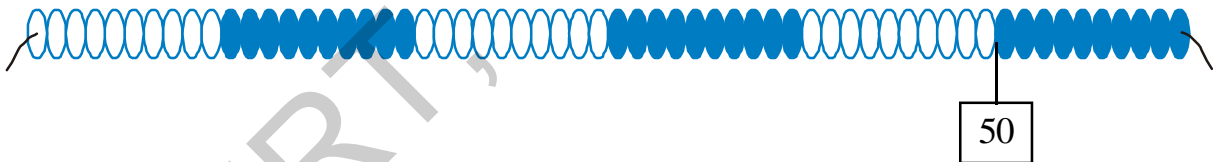

Hang some more tags 54, 78, 85, 63, 92 on the beads chain given below.

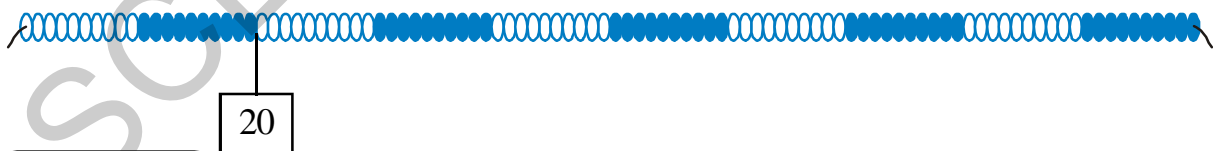

Do These

Now make a beads chain of 100 beads, like the one given above and hang number tags of your choice on it.

Sandhya



Teacher! I can identify the numbers on the number line easily then on the beads chain.

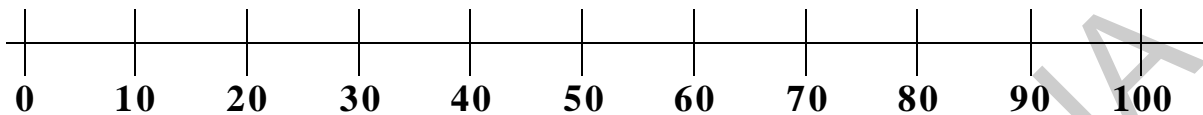

Teacher: Okay Sandhya! Tell me how will you show 37 on this line?

Sandhya: I will place it between 30 and 40, and also nearer to 40 than 30.

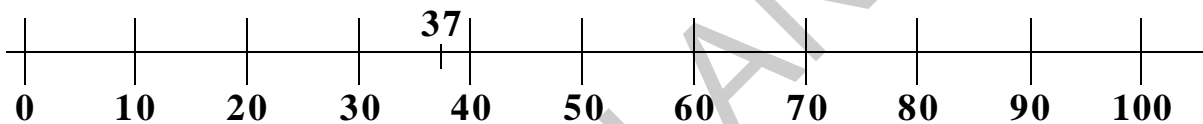

Teacher: Yes, this is a good way of showing it. Now, show me these numbers on the number line- 41, 59, 63, 75, 82, 99. Help Sandhya to find these numbers on the number line.

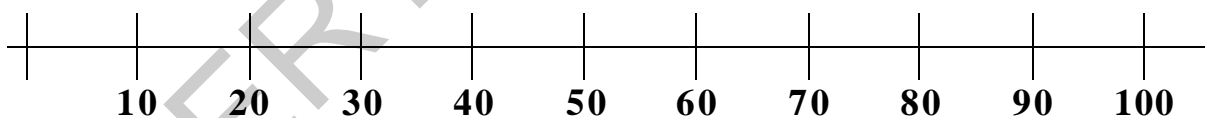

Identify the correct number on the number line given below and write in the allotted boxes.

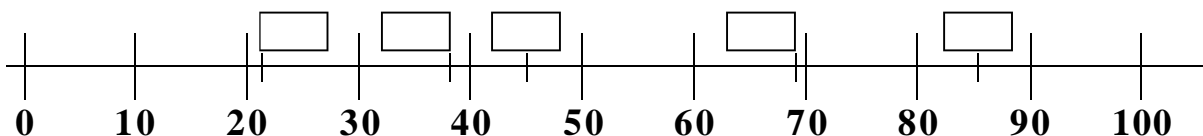

Waheeda's Family

Given below are the ages of Waheeda's family members.



Ibrahim (65)



Razia (62)



Rafiq (42)



Nasim (40)



Hameed (38)



Shahida (33)



Waheeda (15)



Sunir (20)



Fathima (8)



Fahim (12)

(a) Who is the oldest in this family? _____ Age _____

(b) Who is the youngest in this family? _____ Age _____

(c) Who is Ibrahim's elder son? _____ Age _____

(d) Write the names and ages of the four children of the family, in the order from eldest to youngest.

How much money did children save?

6 children saved the following amounts in one month. At the end of that month their savings are as followed.



Teja	Divya	John	Raheem	Sindhu	Ramu
₹ 65	₹ 27	₹ 56	₹ 99	₹ 11	₹ 80

- (a) How much money did John save? _____
- (b) Who saved more than 50 rupees? _____
- (c) Who saved more money among all? _____
- (d) If John has saved only ten rupee notes and one rupee coins. How many ten rupee notes and one rupee coins are there in the amount he saved? _____
- (e) How much money do each of them need to put in their kiddy bank to save 100 rupees?



$$65 + \underline{\hspace{2cm}} = 100$$

$$27 + \underline{\hspace{2cm}} = 100$$

$$99 + \underline{\hspace{2cm}} = 100$$

$$11 + \underline{\hspace{2cm}} = 100$$

$$80 + \underline{\hspace{2cm}} = 100$$

$$56 + \underline{\hspace{2cm}} = 100$$

Can we represent numbers more than 100 on a number line?

Sandhya had represented earlier lots of numbers upto 100 on the number line. Today she made a different number line.

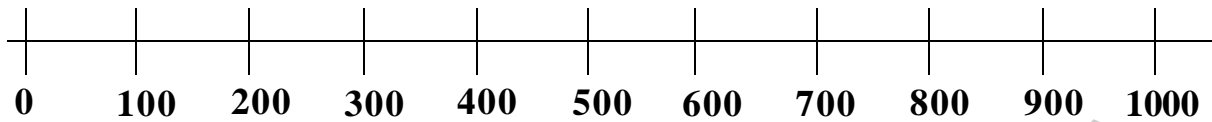

Where will 50 lie on the above number line?

It will be right in the middle of 0 and 100.

Where will 120 lie? It will lie between 100 and 200. It will be closer to 100 than 200. What about 270?. It will be between 200 and 300 and will be closer to 300 than 200.

Now show 390, 410, 560, 750 on this number line.

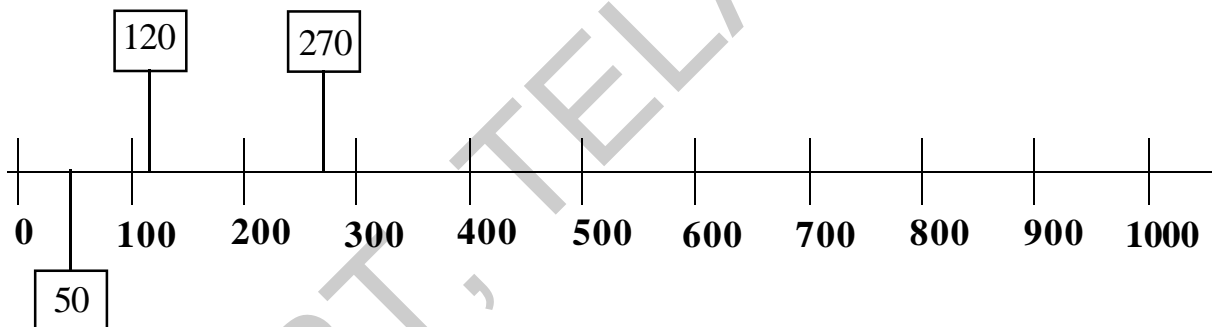

In the same way show 90, 180, 240, 360, 550, 820, 910 on the number line given below.

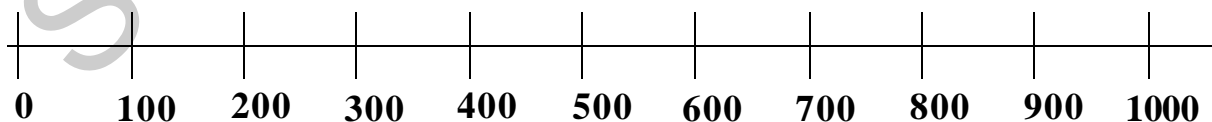

Madhuri is writing the numbers counting beyond 100 in her notebook.

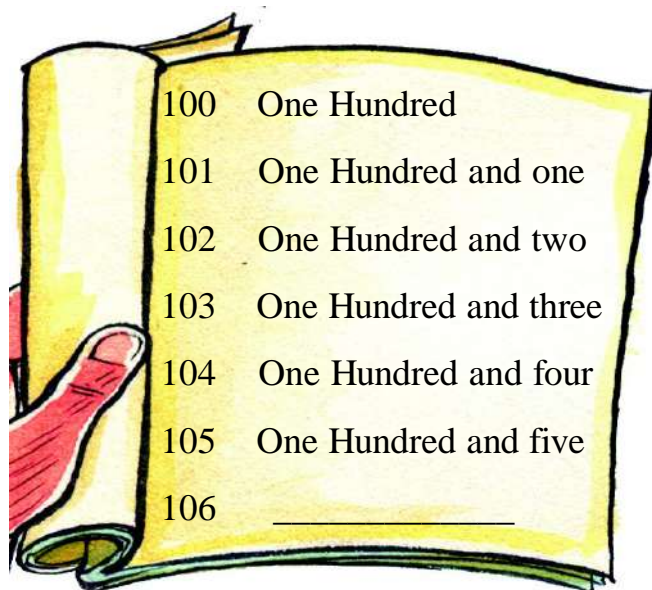

Meena : You do not need to write all the numbers and number names like this. Just remember that 101 is one more than one hundred and is read as one hundred and one. Similarly 105 is five more than one hundred and is read as one hundred and five. 127 is twenty seven more than one hundred and is read as one hundred and twenty seven. We can write and read any number in the same way.

Now write the number names for the following numbers.

137	:	_____
146	:	_____
151	:	_____
168	:	_____
179	:	_____
185	:	_____
198	:	_____

Do These

1. Write the number names of the following numbers.

(a) 247 : two hundred and forty seven

(b) 499 : _____

(c) 391 : _____

(d) 565 : _____

(e) 444 : _____

(f) 288 : _____

(g) 507 : _____

(h) 307 : _____

(i) 790 : _____

(j) 972 : _____

2. Fill the following numerical orders.

(a)

100	125	150							
-----	-----	-----	--	--	--	--	--	--	--

(b)

200	210					260			290
-----	-----	--	--	--	--	-----	--	--	-----

(c)

300	320					420			
-----	-----	--	--	--	--	-----	--	--	--

(d)

400	450					700			
-----	-----	--	--	--	--	-----	--	--	--

(e)

100	200					700			1000
-----	-----	--	--	--	--	-----	--	--	------

3.. Write the appropriate number in the given boxes as shown in the example.

Example: 4 × 100 + 2 × 10 + 2 × 1 = 232

5 × 100 + 5 × 10 + 5 × 1 =

4 × 100 + 6 × 1 =

3 × 100 + 3 × 10 + 2 × 1 =

The teacher asked students to write 399 in its expanded form. Sidhu, Meena and Amar wrote differently.

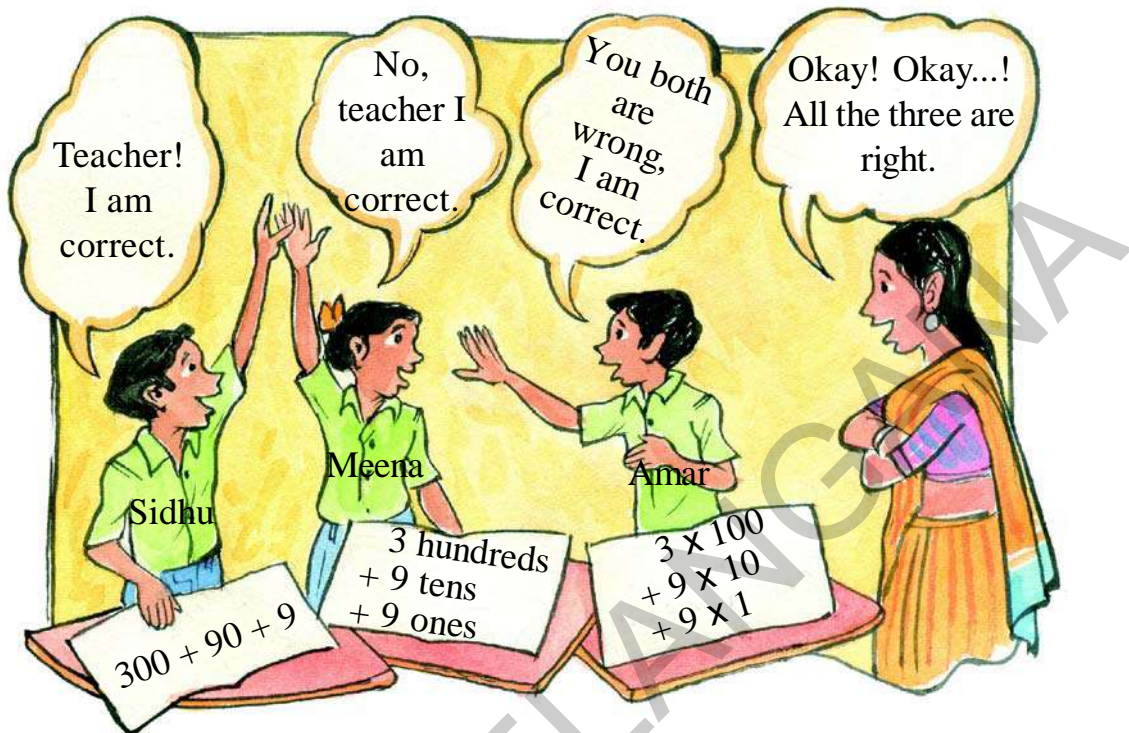

$$\begin{aligned}
 \text{So, } 399 &= 300 + 90 + 9 \\
 &= 3 \text{ hundreds} + 9 \text{ tens} + 9 \text{ ones} \\
 &= 3 \times 100 + 9 \times 10 + 9 \times 1
 \end{aligned}$$

Do These

1. Expand the following numbers in all the three ways as shown above.

(a) $862 =$ _____ $+$ _____ $+$ _____
 _____ $+$ _____ $+$ _____
 _____ $+$ _____ $+$ _____

(b) $602 =$ _____ $+$ _____ $+$ _____
 _____ $+$ _____ $+$ _____
 _____ $+$ _____ $+$ _____

Now try making all possible numbers using these digits.

(a) 4, 5, 6 : _____, _____, _____, _____, _____, _____

(b) 7, 1, 5 : _____, _____, _____, _____, _____, _____

(c) 9, 2, 8 : _____, _____, _____, _____, _____, _____

The top bowlers of world test cricket

The bowlers who have taken the maximum number of wickets in test cricket upto 2012 are given below.

Name of the bowler	Wickets taken	Country
Anil Kumble	619	India
Kapil Dev	434	India
Muralitharan	800	Sri Lanka
Shane Warne	708	Australia
Richard Hadlee	431	New Zealand

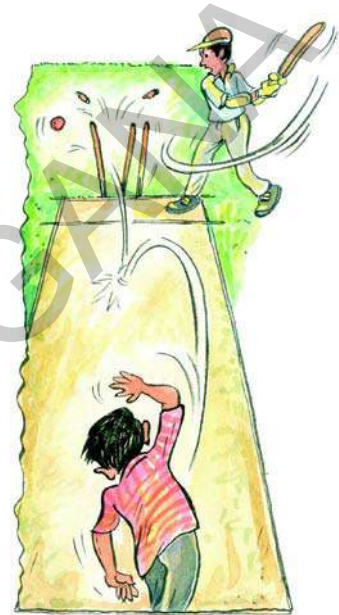

Answer the following:

(a) Which bowler has taken the highest number of wickets? Which country does he belong to? _____

(b) How many bowlers have taken more than 600 wickets? _____

(c) Write the names of the bowlers in the order of wickets taken, from lowest to highest. _____

(d) How many wickets the following bowlers require to take 1000 wickets?

Muralitharan 800 + _____ = 1000

Shane Warne 708 + _____ = 1000

Anil Kumble 619 + _____ = 1000





Try This





- How many 100s are there in 1000? _____
- How many 200s are there in 1000? _____
- How many 500s are there in 1000? _____

Let's fill in the boxes with the next numbers.

- | | | | | | | | |
|------|------|--|--|--|--|------|--|
| 1000 | 1500 | | | | | 4000 | |
|------|------|--|--|--|--|------|--|
- | | | | | | | | |
|------|------|--|--|--|--|------|--|
| 2000 | 3000 | | | | | 8000 | |
|------|------|--|--|--|--|------|--|
- | | | | | | | | |
|------|------|--|--|--|--|--|--|
| 2000 | 4000 | | | | | | |
|------|------|--|--|--|--|--|--|

Write the appropriate number in the box.

		
		
		<input type="text"/>

				<input type="text"/>
---	---	---	---	----------------------

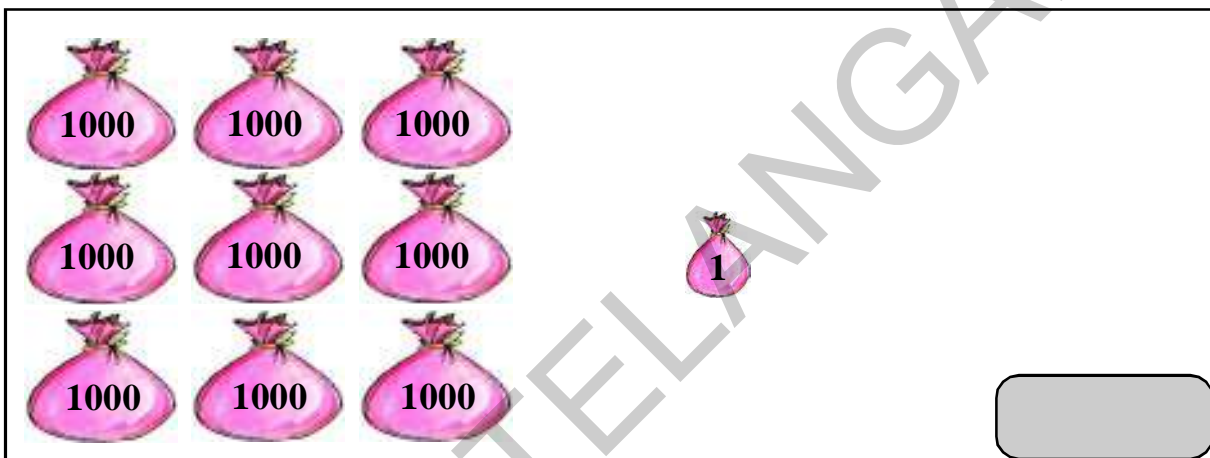

Exercise



1. The highest scores of batsmen in an innings in one day International cricket match till 2012 are given below.

Name of Batsman	Runs Scored	Country
Saeed Anwar	194	Pakistan
Sachin Tendulkar	200	India
Virendra Sehwag	219	India
M.S. Dhoni	183	India
Vivian Richards	189	West Indies

- (a) Which batsman scored the highest number of runs in an innings in one day International cricket? To which country does he belong? _____
- (b) Which batsmen have scored runs between 100 and 200 ? _____
- (c) Which batsmen have scored double century? (century = 100) _____
- (d) Write the names of batsmen in the order of their runs, scored, from highest to lowest _____, _____, _____, _____, _____,

2. Given below is the approximate weight of some animals.

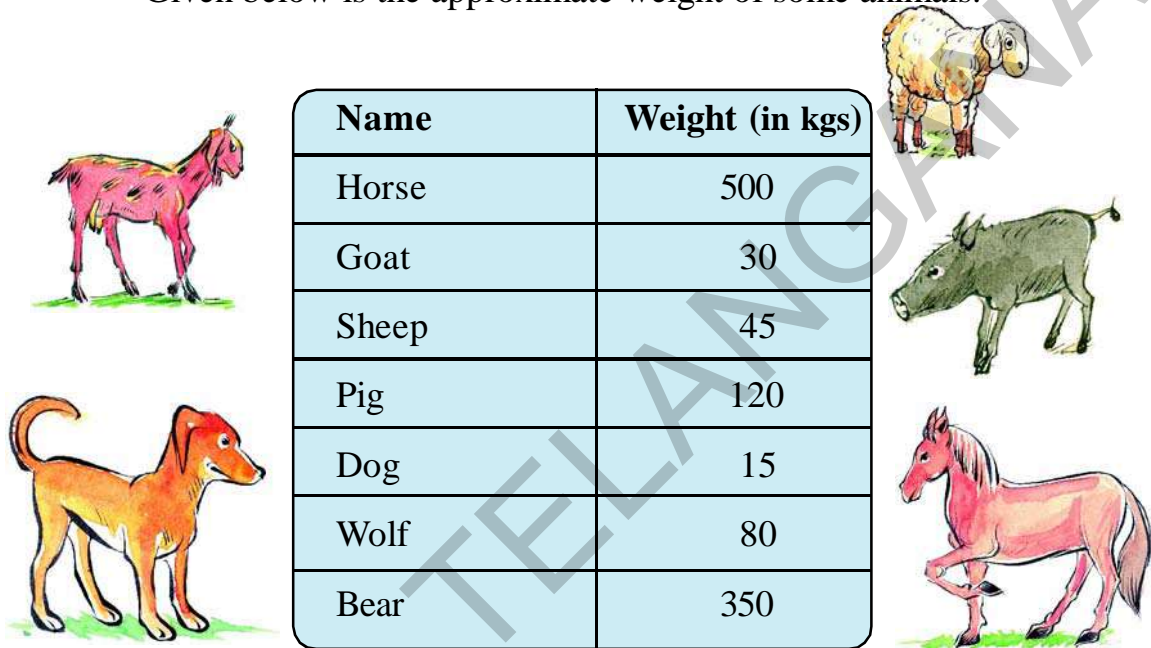

Name	Weight (in kgs)
Horse	500
Goat	30
Sheep	45
Pig	120
Dog	15
Wolf	80
Bear	350

- (a) As per above table, which is the heaviest animal?
 - (b) Write the name of the animals which weigh more than 100 kg?
 - (c) Write the names of animals in the order of their weights, from the lightest to the heaviest.
 - (d) How many goats weight will be equal to a pig's weight?
 - (e) How many dogs weight will be equal to a sheep's weight?
3. I am a two digit number with 6 in the units place and 1 in the tens place. Who am I?
 4. I lie between 30 and 40. The digit in my units place is the same as the digit in my tens place. Who am I?
 5. Find all the two digit numbers, whose digit in the tens place is twice the digit in the units place.

6. Find all the two digit numbers having the same digit in the units and tens place.
7. I am a three digit number. The digit in my hundreds place is 6, the digit in my tens place is 0 and the digit in my units place is 9. Who am I?
8. Find all the three digit numbers whose digit in the hundreds place is three times the digit in the units place and the digit in the tens place is 1.
9. Find all the numbers that lie between 500 and 600 whose digit in the units place is the same as the digit in the tens place.
10. Gauri has two thousand and two ten rupee notes. How much money does she has?
11. Write the expanded forms of the following numbers.

(a) $347 = \underline{\quad\quad} + \underline{\quad\quad\quad\quad} + \underline{\quad\quad\quad\quad}$
 $\quad\quad\quad\quad + \underline{\quad\quad\quad\quad} + \underline{\quad\quad\quad\quad}$
 $\quad\quad\quad\quad + \underline{\quad\quad\quad\quad} + \underline{\quad\quad\quad\quad}$

(b) $804 = \underline{\quad\quad} + \underline{\quad\quad\quad\quad} + \underline{\quad\quad\quad\quad}$
 $\quad\quad\quad\quad + \underline{\quad\quad\quad\quad} + \underline{\quad\quad\quad\quad}$
 $\quad\quad\quad\quad + \underline{\quad\quad\quad\quad} + \underline{\quad\quad\quad\quad}$

(c) $532 = \underline{\quad\quad} + \underline{\quad\quad\quad\quad} + \underline{\quad\quad\quad\quad}$
 $\quad\quad\quad\quad + \underline{\quad\quad\quad\quad} + \underline{\quad\quad\quad\quad}$
 $\quad\quad\quad\quad + \underline{\quad\quad\quad\quad} + \underline{\quad\quad\quad\quad}$

12. Fill the blanks appropriately.

(a) 456 : Four hundred and fifty six

(b) 631 : _____

(c) _____ : Eight hundred and seventy six

(d) _____ : Nine hundred and sixty eight

13. What are the largest and smallest three digit numbers that you can make with the given digits?

(a) 7, 6, 3 _____ , _____

(b) 3, 4, 2, 9 _____ , _____

5 How much more - How much less?



The teacher exhibited the beads chain in the class and wrote a problem on the blackboard. Teacher asked the children to use the beads chain to find the answer to the problem.

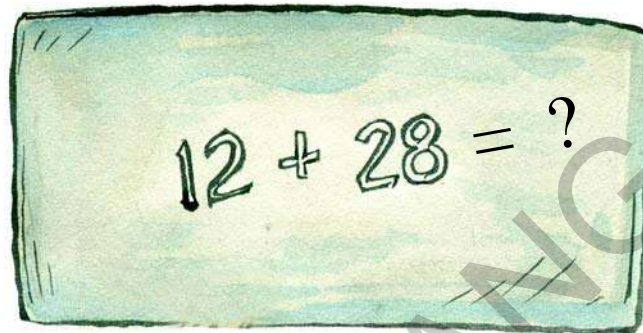

Children solved the problem in different ways on the beads chain.

Sudha did it like this.

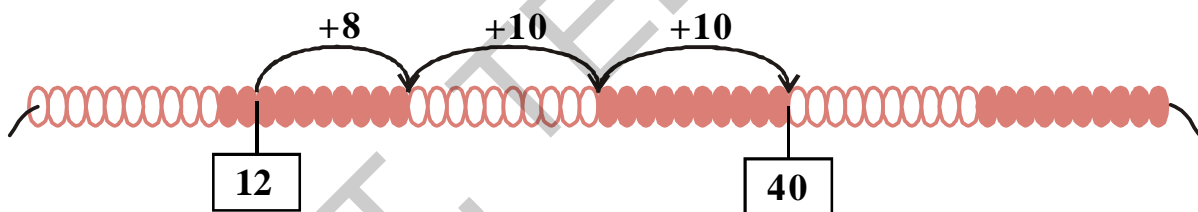

She wrote- $12 + 28 = 12 + 8 + 10 + 10 = 40$

Karuna did it like this.

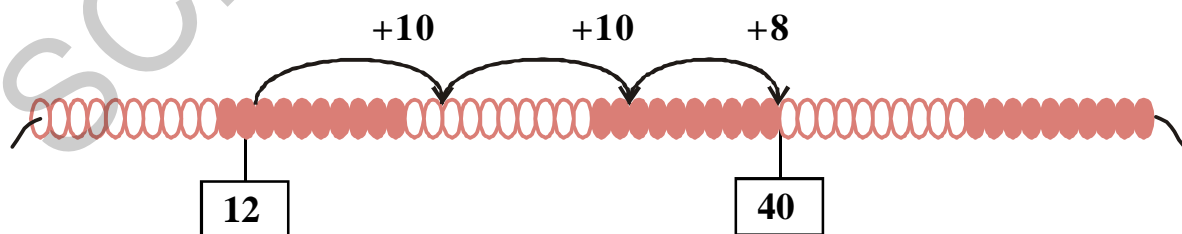

She wrote- $12 + 28 = 12 + 10 + 10 + 8 = 40$

Rajendra did it like this.

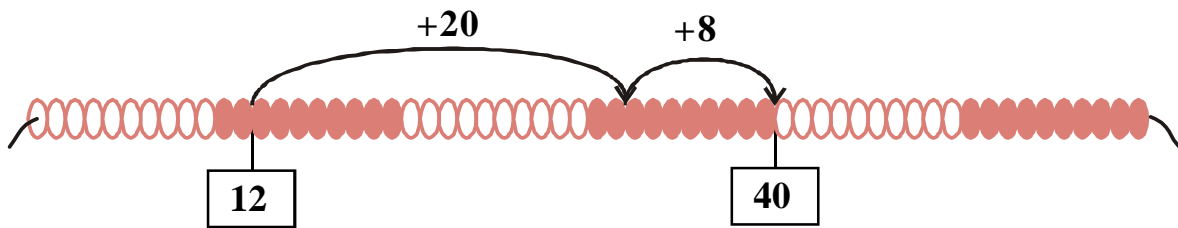

He wrote- $12 + 28 = 12 + 20 + 8 = 40$

Now, solve the following on the beads chain in whichever way you want and find the sum and write.

1. $34 + 16 =$

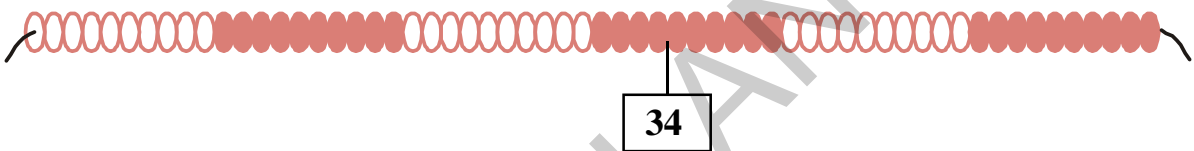

2. $25 + 23 =$

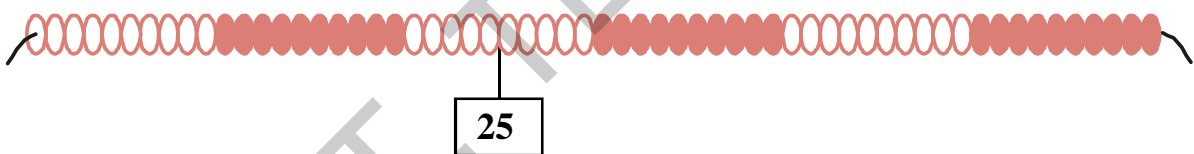

3. $41 + 23 =$

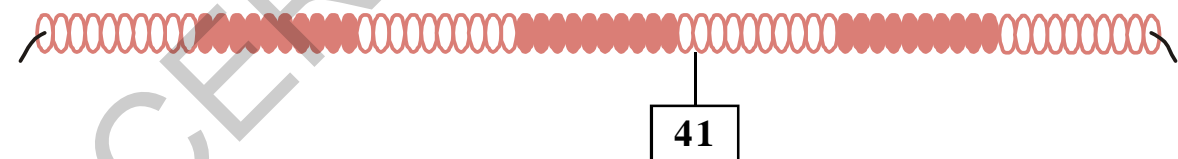

4. $53 + 12 =$



The teacher wrote this problem on the board.

$$37 - 19 = ?$$

Children solved the problem differently on the beads chain.

Sudha did it like this.

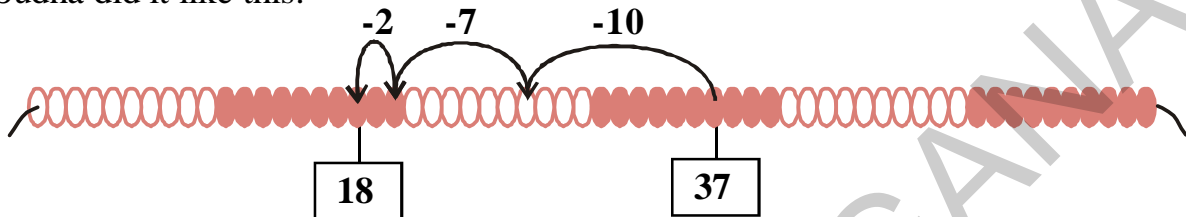

She wrote- $37 - 19 = 37 - 10 - 7 - 2 = 18$

Karuna did it like this.

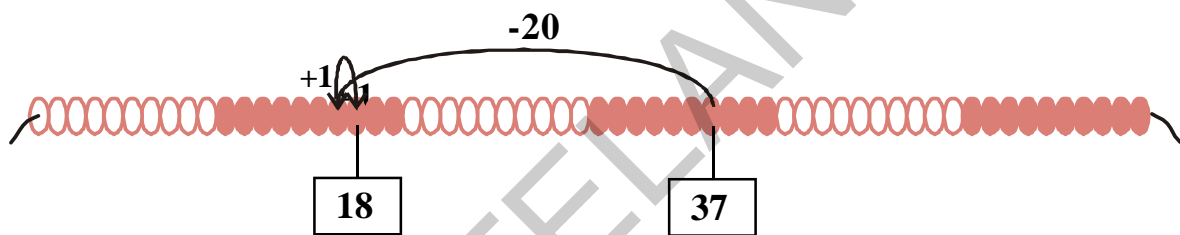

She wrote- $37 - 19 = 37 - 20 + 1 = 18$

Now, solve the following on the beads chain in whichever way you want and find the difference and write.

(a) $42 - 12$

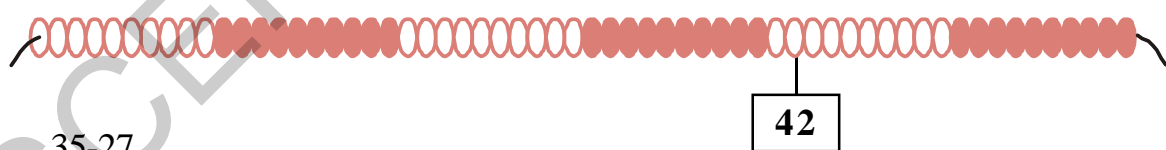

(b) $35 - 27$

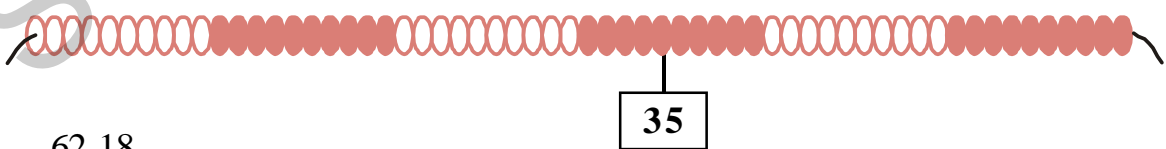

(c) $62 - 18$



The teacher then asked the children to solve these problems in their note books.

(a) $49 + 17$

(b) $83 - 24$

Sudha did it like this-

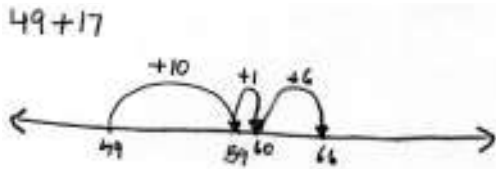

$$49 + 17 = 49 + 10 + 1 + 6 = 66$$

Kamala did it like this-

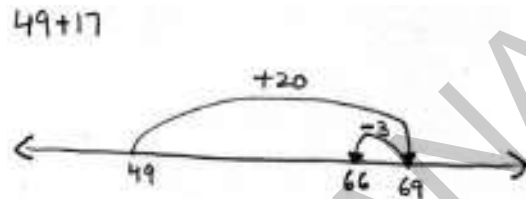

$$49 + 17 = 49 + 20 - 3 = 66$$

Sudha did the subtraction like this-

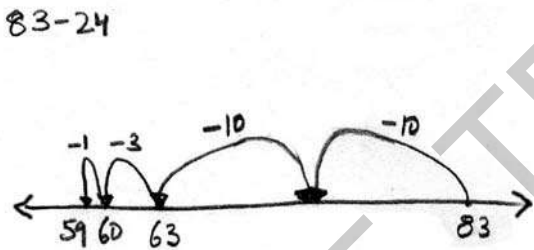

$$83 - 24 = 83 - 10 - 10 - 3 - 1 = 59$$

Kamala did the subtraction like this-

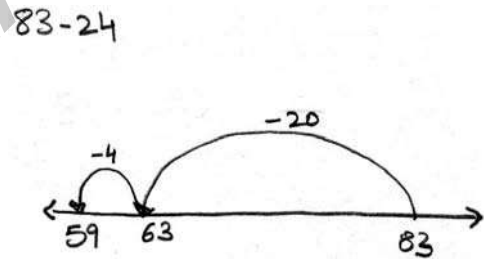

$$83 - 24 = 83 - 20 - 4 = 59$$

Do These

1. Solve the following using number line.

(a) $46 + 37 = ?$

(b) $63 - 35 = ?$

(c) $77 - 29 = ?$

(d) $42 + 38 = ?$

London Olympics Medal Winners - 2012

The London Olympics medal score sheet given below is incomplete. Complete it by understanding the score sheet.



Country	Gold	Silver	Bronze	Total
America	46	29	29	
China	38	27	23	
Britain	29	17		65
Russia	24		32	82
Korea	13	8		28
France		11	12	34
Australia	7	16	12	
Italy	8		11	28
Hungary		4	5	17
Japan	7	14		38

- How many medals did America get more than Italy?
- How many medals did Korea get less than Russia?
- How many more medals does China need to reach the number of medals as that of America?
- Make more problems on addition and subtraction based on the table given above.

Try This

Solve these problems and fill in the blanks. An example is given.

Example: $27 + 52 = 79$

(a) $73 - 41 = 32$

$79 - 52 = \underline{27}$

$32 + \underline{\quad} = 73$

(b) $36 + 56 = 92$

(c) $91 - 37 = 54$

$92 - \underline{\quad} = 56$

$\underline{\quad} + 37 = 91$

Let's estimate!

Sridhar and Gayatri have gone to a "jathara". Let's see what they purchased.

Sridhar spent ₹ 68 on food and ₹ 99 on toys at the jathara. About how much money did Sridhar spend at the jathara?

It's always easy to add numbers when they are in tens. 68 is closer to 70, so I can say that I spent about ₹ 70 on food. Similarly, I spent about ₹ 100 on toys. So I spent about $70 + 100 = ₹ 170$ in the jathara.



I had about ₹ 100 when I went to the Jathara and spent about ₹ 40. So I have about ₹ 60 left with me.

Gayatri had ₹ 98 when she went to the jathara. She spent ₹ 42. About how much money is left with her?

Do These

Estimate the answers of the following problems?

- Sandhya spent ₹ 91 on fruits and ₹ 82 on vegetables. About how much money did she spend in all?
- Gopal went to the market with ₹ 78. He spent ₹ 29. About how much money does Gopal have now?
- Somaiah earned ₹ 89 on Monday and ₹ 57 on Tuesday. About how much money Somaiah earned in all?
- There are 87 trees in a grove. During a storm 28 fell down. About how many trees are still in the grove?

- (e) About how much is the sum of 58 and 33?
- (f) About how much is the difference between 91 and 33?
- (g) Kamal bought 84 diyas for Diwali. He used 28 diyas a day before Diwali. About how many diyas are left for Diwali day?

Ler's do addition and subtraction of bigger numbers!

The teacher is doing addition of bigger numbers in class today. Hence wrote a problem on the board.

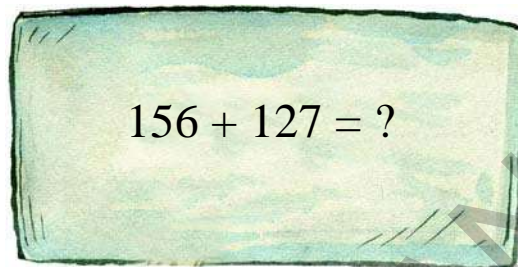

$$156 + 127 = ?$$

Will the sum be bigger than 300 or smaller than 300?

The children did the problem in their notebook in this way.

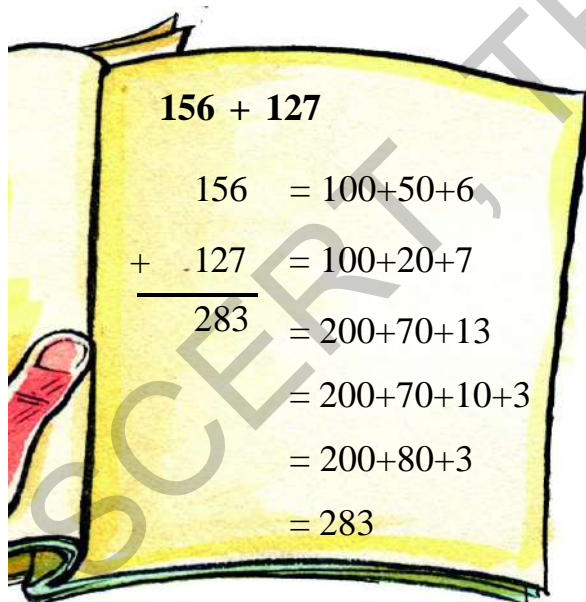

$$\begin{array}{r}
 156 + 127 \\
 156 = 100 + 50 + 6 \\
 + 127 = 100 + 20 + 7 \\
 \hline
 283 = 200 + 70 + 13 \\
 = 200 + 70 + 10 + 3 \\
 = 200 + 80 + 3 \\
 = 283
 \end{array}$$



Sudha

I split both numbers into hundreds, tens and ones. Then I added the hundreds to the hundreds, the tens to the tens and the ones to the ones.

$$\begin{array}{r} 1 \\ 156 \\ + 127 \\ \hline 283 \end{array}$$



George

First, I placed the numbers one below the other such that the digits in the ones, tens and hundreds place are placed one below the other. Then, I added the digits in the ones place and from this sum I transferred one ten to tens place. After this I added the digits in the tens place. To this I added the ten I had carried forward from the ones place. Lastly, I added the digits in the hundred's place.

Teacher: Both of you have used different methods and both of your answers are correct.

Discuss with your friends the differences in the two processes.

The next day the teacher decided to do subtraction. So, wrote a problem on the board

$$279 - 146 = ?$$

Will the difference be less than 100 or more than 100.

$$\begin{array}{r} 279 \\ - 146 \\ \hline 133 \end{array}$$

$$\begin{array}{r} 200 + 70 + 9 \\ - 100 + 40 + 6 \\ \hline 100 + 30 + 3 \end{array}$$



Sudha

Since 146 is being subtracted from 279, I wrote 146 below 279.

Then I split both numbers into hundreds, tens and ones.

I started from the units place. I took away 6 from 9, Then I subtracted 40 from 70 and then 100 from 200.

Then teacher changed the numbers and asked children to solve it.

$$\begin{array}{r} 6 \quad 16 \\ 2 \quad \cancel{7} \quad \cancel{6} \\ - 1 \quad 4 \quad 9 \\ \hline 1 \quad 2 \quad 7 \end{array}$$



Since 149 is being subtracted from 276, I wrote 149 below 276 in such a way that the digits in the ones, tens and hundreds place are placed one below the other. I started subtracting from the units place.

Since 9 ones cannot be subtracted from 6 ones, I borrowed 1 ten from 7 tens. So I now had 16 ones from which I subtracted the 9 ones. I got 7 ones. Then I subtracted 4 tens from 6 tens to get 2 tens and 1 hundred from 2 hundreds and got 1 hundred.

Do These

1. Kavita had ₹ 73 in her purse. She got back ₹ 28 from a friend, who owed her money. How much money does Kavita have now?
2. Somaiah earns in a day ₹ 92 and spends ₹ 67 on food and other necessary items for his home. How much money does Somaiah take home?
3. 234 tamil movies were released in a year. If the number of telugu movies released in the same year is 67 more than the number of tamil movies, how many Telugu movies were released in the year?
4. Sachin scored 184 runs in a match and Yuvraj Singh scored 48 runs less than him. How many runs did Yuvraj Singh score in the match?
5. There were 545 kg of rice lying in the godown. 228 kg were distributed to various shops. Now how much rice is in the godown?
6. Vasudha went to shopping with her mother to buy clothes. They bought one saree for ₹ 512 and one dress material for ₹ 309. What is the total amount they spent on clothes?
7. Shreya has ₹ 149 in her purse. She needs to give the shopkeeper ₹ 268. How much more money does Shreya need to pay to the shopkeeper?

Let's estimate!

Laxmi had ₹ 384 in her purse when she went to the market. She spent ₹ 106. About how much money is left with her?

Just like it was easy to subtract 10s, it is also easy to subtract 100s.

Laxmi took about ₹ 400 to the market and spent about ₹ 100. So she has about ₹ 300 left.

Now, you estimate and tick the option closest to the answer.

- (a) Rajendra has ₹ 618 and his brother Ravi has ₹ 321. About how much money do they have in all? 800 900 1000
- (b) Ranga earned ₹ 268 in a day and spent ₹ 99 on food. About how much money did Ranga save in a day? 100 200 300
- (c) About how much more is 904 than 418? 400 500 600
- (d) There are 467 kg of wheat and 376 kg of rice in godown. About how many kg of grain is there in the godown? 800 900 1000
- (e) About how much is the sum of 589 and 218? 800 900 1000
- (f) About how much more is 386 than 298? 50 100 150

Try This

Is $9 + 8 = 8 + 9$? Is $14 + 7 = 7 + 14$? Is $29 + 42 = 42 + 29$?



Take any two numbers, add and see if the above rule is true for all?

1. Fill in these blanks.

- (a) $12 + 9 = \underline{\quad} + 12$
- (b) $17 + 14 = 14 + \underline{\quad}$
- (c) $40 + 50 = \underline{\quad} + 40$
- (d) $39 + 67 = \underline{\quad} + 39$
- (e) $97 + 101 = 101 + \underline{\quad}$
- (f) $125 + \underline{\quad} = 143 + 125$
- (g) $\underline{\quad} + 315 = 315 + 270$

Exercise



- 36 people were travelling in a bus. 8 got down at a bus stop and 9 got into the bus. How many people are there in the bus now?
When the bus reached the next stop, 14 people got down and 6 got into the bus. How many people are there in the bus now?
- Sudha has ₹ 75. Radha has ₹ 19 less than Sudha. How much money does Radha have? How much money do both of them have together?
- Kumar has ₹ 37 and his sister Lata has ₹ 56. How much do they have in all? Together they spent ₹ 90 in the market. How much money is left with them?
- In an election, the winner got 273 votes. The loser got 45 votes less than the winner. How many votes did the loser get?
-  Father purchased a pant and a shirt for ₹ 349 for his son and a frock for ₹ 399 for his daughter. He gave ₹ 1000 to the shop keeper. How much money will the shopkeeper return? 
- A fruit seller purchased 840 bananas on Tuesday. He sold 612 bananas in a week and 18 got spoiled. How many bananas does he have at the end of the week?
- Somaiah earned ₹ 175 and his wife earned ₹ 125 on Monday. They spent ₹ 25 for rice, ₹ 18 for vegetables and ₹ 57 for other things on that day. How much money did they save in that day?
- In a test match, the Indian cricket team scored 517 runs. Laxman scored 137 and Dravid scored 165 runs. How many runs were scored by the rest of the team?
- Rajaiah has 348 sheep. Mallaiah has 49 less than that of Rajaiah. The number of sheep that Somaiah has is equal to the total number of sheep that Rajaiah and Mallaiah have together. i) How many sheep does Somaiah have? ii) How many sheep do the three have altogether?

6



How many times?

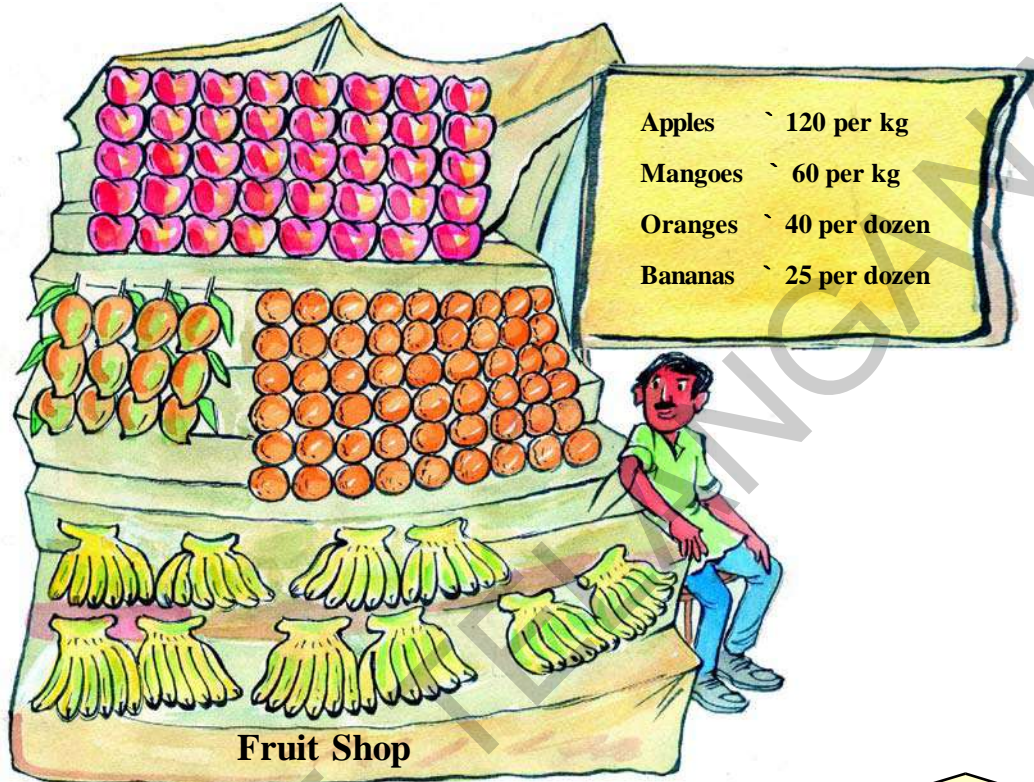

1. How many apples are there in the shop?
How many rows of apples are there? _____
How many apples are there in each row? _____
2. The price of apples is how many times the price of mangoes?
3. Raju bought 2 dozens of bananas in a shop. How much money does he need to pay to the fruit seller?
4. Karuna came and bought 3 kgs of mangoes and 1 kg of apples. How much money does she need to give to the shopkeeper?

1 dozen = 12

Can you make more questions like those given above based on the picture.

Magic pipes in Laltekdi village

Once upon a time there were 4 magic pipes in Laltekdi village.

Whatever went into this pipe is doubled.

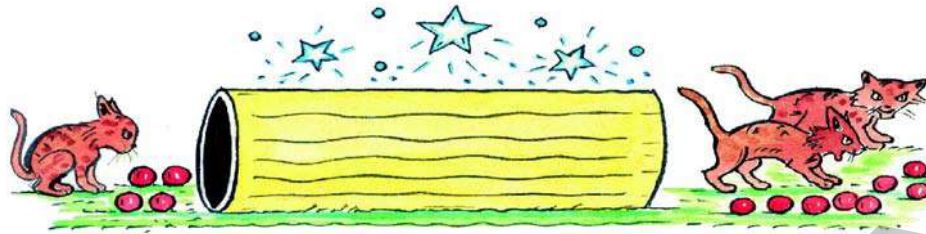

When 1 cat walked into the pipe 2 cats came out.

When 4 balls were thrown into the pipe 8 came out.

- (a) If 6 birds walk into the pipe, how many will come out? _____

Whatever went into this pipe it became three times.

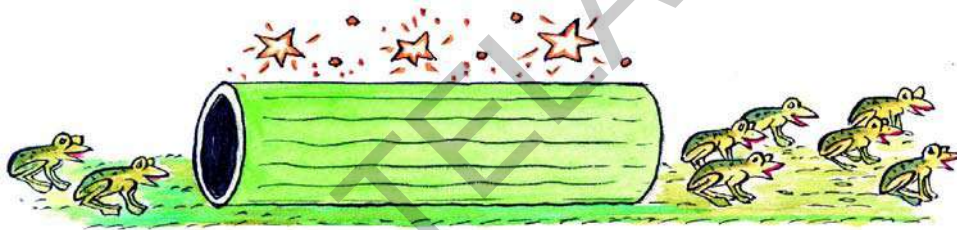

When 2 frogs jumped into the pipe 6 frogs came out.

- (a) If 6 pigs walk into the pipe, how many will come out? _____

Whatever went into this pipe it became six times.

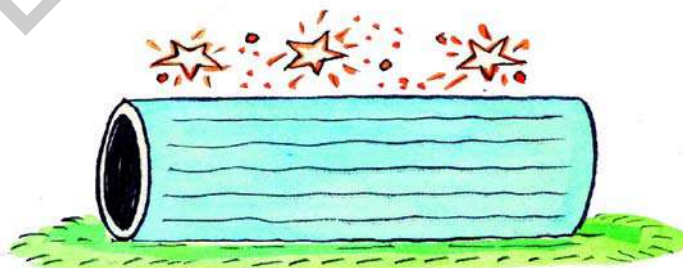

- (a) If 7 birds walk into the pipe, how many will come out? _____
(b) If 8 dogs walk into the pipe, how many will come out? _____

Whatever went into this pipe it became 8 times.

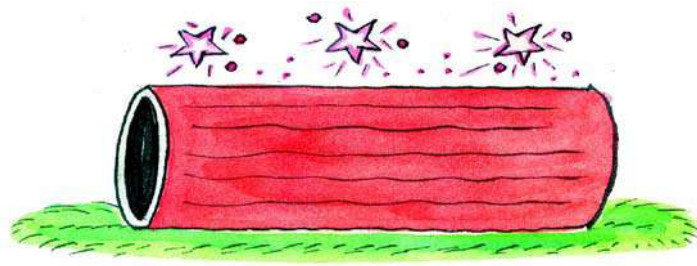

- (a) If 9 spiders walk into the pipe, how many will come out? _____
- (b) If 8 ants crawl into the pipe, how many will come out? _____

Split numbers and multiply

Shravika and Vamshi were playing with multiplication tables.



- Vamshi : What is 8 times 7?
- Shravika : 56
- Shravika : What is 13 times 6?
- Vamshi : I do not know. I only know tables till 10.

Shravika : You can answer this question even without knowing the 13 table. Just split up 13 into 10 and 3. Then multiply these numbers by 6 and add the products. Let me show this to you in your notebook.

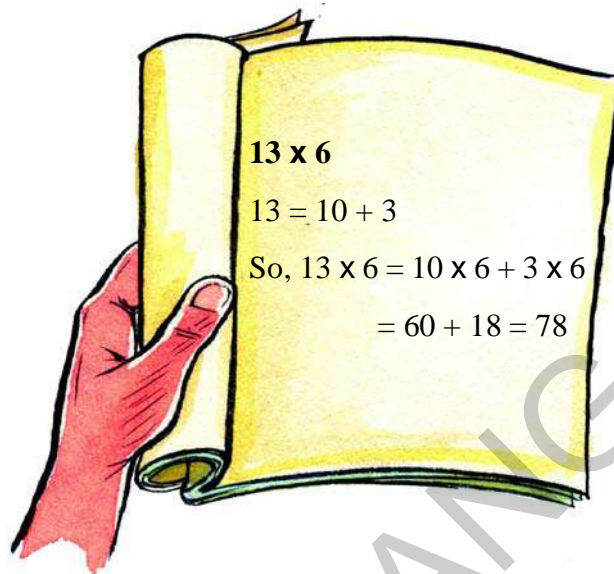

Vamshi : You are right! I can split 13 into 5 and 8 also.

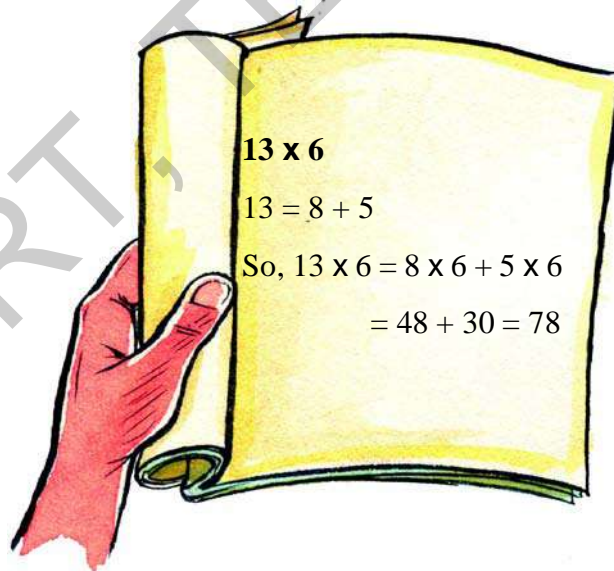

Shravika : Yes, splitting a number into smaller numbers and multiplying makes multiplication easier.

Do These

- Split the numbers and multiply. Also, see how your friends have solved the problems.
(a) 18×9 (b) 17×6 (c) 19×8 (d) 26×7
- In a plantation there are 12 rows of mango trees. If in each row there are 10 trees, how many mango trees are there in the plantation?
- There are 18 rows in a bus. 5 passengers can sit in each row. How many passengers can sit in the bus? How many passengers can sit in 3 such buses?
- Rani's age is 9 years. Her mother's age is thrice her age. What is Rani's mother's age?
- If 4 children can sit on a bench in the classroom, then how many children can sit on 22 such benches?
- One pen costs ₹ 8. How much is the cost of 48 pens?

Packets and boxes of pencils

A packet contains 10 pencils.

- How many pencils do 2 packets have? $2 \times 10 = 20$
- How many pencils do 3 packets have? $3 \times 10 = 30$
- How many pencils do 4 packets have? $4 \times 10 = 40$
- How many pencils do 8 packets have? _____
- How many pencils do 10 packets have? _____
- How many pencils do 14 packets have? _____
- How many pencils do 26 packets have? _____
- How many pencils do 57 packets have? _____



Now, if a box contains 10 such packets of pencils, how many pencils are there in the box? $10 \times 10 = 100$

- (a) How many pencils do 2 such boxes have? $2 \times 100 = 200$
 (b) How many pencils do 4 such boxes have? $4 \times 100 = 400$
 (c) How many pencils do 6 such boxes have? _____
 (d) How many pencils do 8 such boxes have? _____
 (e) How many pencils do 10 such boxes have? _____



Observe the pattern and fill the blanks.

$2 \times 20 = 40$	$2 \times 30 = 60$	$2 \times 40 = 80$
$3 \times 20 = 60$	$3 \times 30 = 90$	$3 \times 40 = 120$
$4 \times 20 = 80$	$4 \times 30 = 120$	$4 \times 40 = 160$
$5 \times 20 = 100$	$5 \times 30 = 150$	$5 \times 40 = 200$
$6 \times 20 = \underline{\hspace{2cm}}$	$6 \times 30 = \underline{\hspace{2cm}}$	$6 \times 40 = \underline{\hspace{2cm}}$
$7 \times 20 = \underline{\hspace{2cm}}$	$7 \times 30 = \underline{\hspace{2cm}}$	$7 \times 40 = \underline{\hspace{2cm}}$
$8 \times 20 = \underline{\hspace{2cm}}$	$8 \times 30 = \underline{\hspace{2cm}}$	$8 \times 40 = \underline{\hspace{2cm}}$
$9 \times 20 = \underline{\hspace{2cm}}$	$9 \times 30 = \underline{\hspace{2cm}}$	$9 \times 40 = \underline{\hspace{2cm}}$
$10 \times 20 = \underline{\hspace{2cm}}$	$10 \times 30 = \underline{\hspace{2cm}}$	$10 \times 40 = \underline{\hspace{2cm}}$
$11 \times 20 = \underline{\hspace{2cm}}$	$11 \times 30 = \underline{\hspace{2cm}}$	$11 \times 40 = \underline{\hspace{2cm}}$
$12 \times 20 = \underline{\hspace{2cm}}$	$12 \times 30 = \underline{\hspace{2cm}}$	$12 \times 40 = \underline{\hspace{2cm}}$

Try This

- Multiply a series of numbers with 50, 60 and 70. What is the pattern that you observe? Is it the same as shown above?

Are they equal?

- (a) $2 \times 8 = \underline{\quad}$ (b) $6 \times 7 = \underline{\quad}$ (c) $9 \times 8 = \underline{\quad}$
 $8 \times 2 = \underline{\quad}$ $7 \times 6 = \underline{\quad}$ $8 \times 9 = \underline{\quad}$
- (d) $10 \times 5 = \underline{\quad}$ (e) $12 \times 3 = \underline{\quad}$ (f) $13 \times 5 = \underline{\quad}$
 $5 \times 10 = \underline{\quad}$ $3 \times 12 = \underline{\quad}$ $5 \times 13 = \underline{\quad}$

Take any two numbers of your choice, multiply as above. See whether the above relationship is true? Do this with as many numbers as you want.

What conclusion can you draw?

Do These

1. Fill in the blanks

- (a) $8 \times 9 = \underline{\quad} \times 8$ (b) $4 \times 10 = \underline{\quad} \times \underline{\quad}$
(c) $7 \times 100 = \underline{\quad} \times \underline{\quad}$ (d) $16 \times 5 = 5 \times \underline{\quad}$
(e) $9 \times \underline{\quad} = 15 \times 9$ (f) $9 \times 70 = \underline{\quad} \times \underline{\quad}$
(g) $12 \times 50 = \underline{\quad} \times \underline{\quad}$ (h) $\underline{\quad} \times \underline{\quad} = 8 \times 23$

2. Observe the example and fill in the boxes.

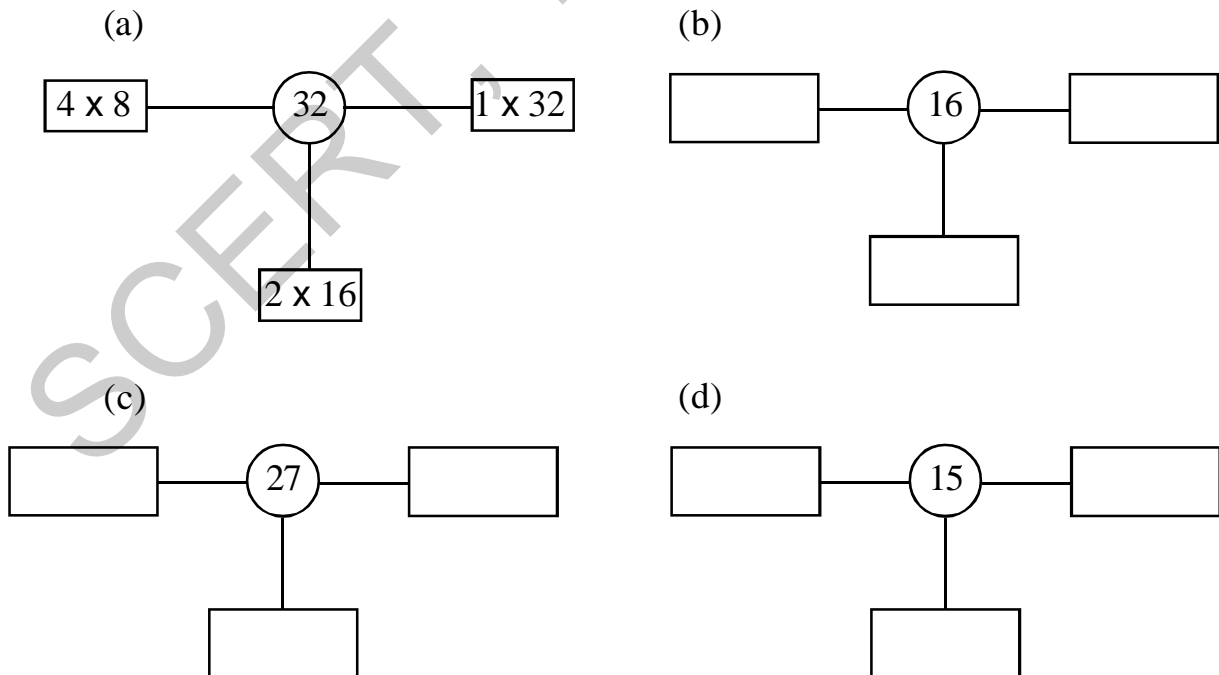

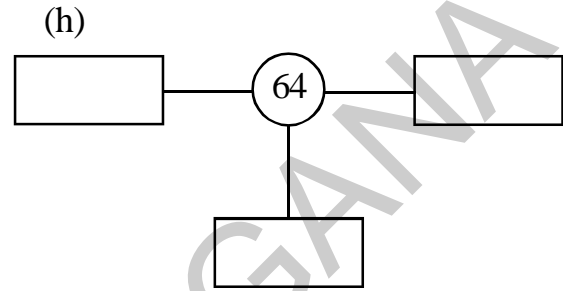
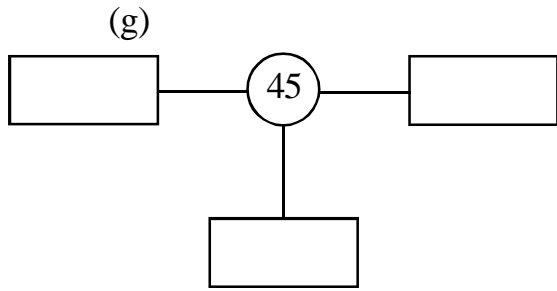
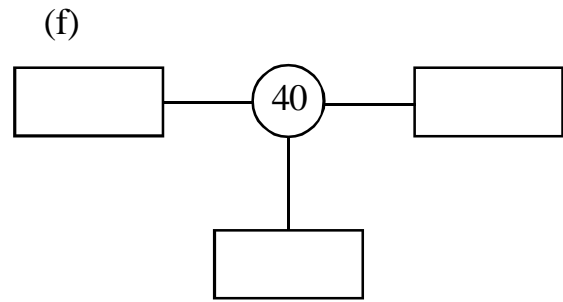
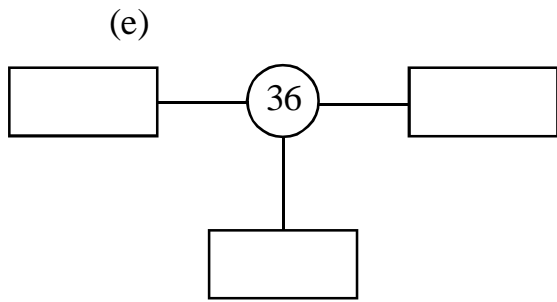

3. Make word problems on multiplication using the information provided in the pictures given below.

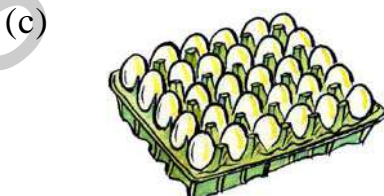
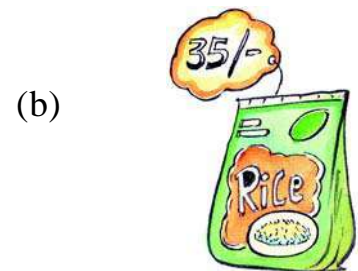

Multiplying bigger numbers

The teacher then wrote this word problem on the board-

If a bag of rice costs ₹ 325 then how much will three bags cost?

$$325 \times 3 = ?$$

Sita and Dharma did this problem differently.

Sita did it like this-

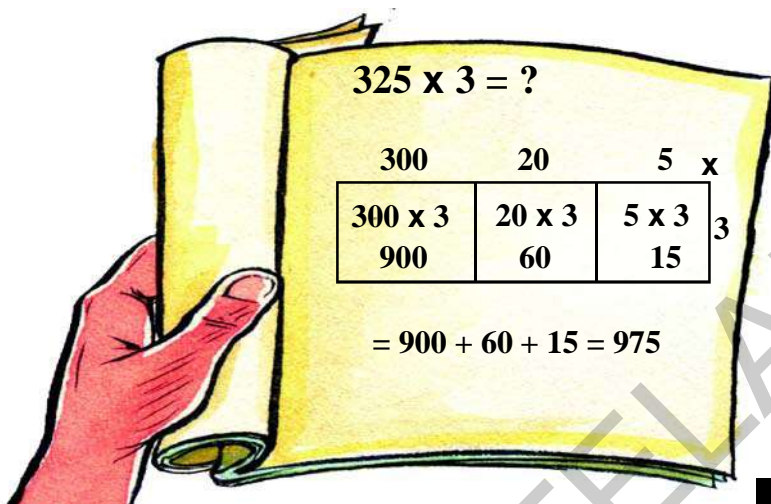

$325 \times 3 = ?$

300	20	5	x
300×3	20×3	5×3	3
900	60	15	

$= 900 + 60 + 15 = 975$

I first split 325 into 100s, 10s and 1s. I first multiplied 300 with 3, then 20 with 3 and then 5 with 3. In the end I added all the products.



Dharma did it like this-

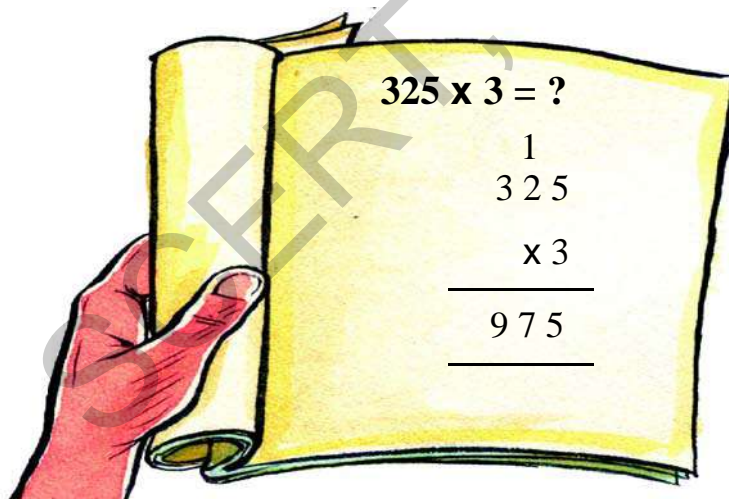

$325 \times 3 = ?$

$$\begin{array}{r} 1 \\ 325 \\ \times 3 \\ \hline 975 \end{array}$$

I first multiplied the digit in the units place with 3. The product was 15. I carried over the 10 in 15 to the tens place showed this by writing 1 on top of 2. And I have written 5 in one's place in the result.

I then multiplied the digit in the tens place with 3. I added the 1 that I had carried over to this product and wrote 7 in the tens places.

Then I multiplied the digit in the hundreds place with 3. I have written 9 in hundred's place in the result

The teacher then wrote this problem on the board-

$$45 \times 23 = ?$$

Sita did it like this-

40	5	x	
800	100		20
		+	3
120	15		

$$45 \times 23 = 800 + 100 + 120 + 15 = 1035$$

Sita has split both 45 and 23 and then multiplied

Dharma did it like this-

$$\begin{array}{r}
 1 \\
 45 \\
 \times 23 \\
 \hline
 135 \\
 900 \\
 \hline
 1035
 \end{array}$$

Teacher : Good! All of you have used different methods. All your answers are correct. Discuss with your friends the differences in the methods.

Do These

1. Use Sita, & Dharma's methods to solve the problems given below.
 - (a) 85×21
 - (b) 157×4
2. In a function hall chairs are arranged in 35 rows. Each row contains 19 chairs. What is the total number of chairs arranged in the function hall?
3. The weight of one bag of rice is 50 kgs. How much do 17 such bags weigh?
4. The weight of a goat is 27 kgs. If the weight of a horse is 18 times more than the weight of the goat, then what is the weight of the horse?
5. The bus ticket from Nalgonda to Miryalguda costs ` 38. If 42 passengers travel in this route, how much money will they pay for the bus tickets?
6. A machine wraps 235 boxes of toys in an hour. How many boxes of toys can it wrap in 4 hours?
7. A truck can carry 140 bags of cement. How many bags of cement can five such trucks carry?

Just estimate !

The teacher asked Sudha, about how many people are there in your village?

There are 40 families in my village. Some families have 3 members or less and some have 4-5 members. Let me assume that all families have 4 members each.



So about $40 \times 4 = 160$ people are living in my village.

(a) Now, can you estimate the number of people living in your village?

The teacher then wrote this problem on the board and asked children to choose an answer closest to the correct answer.

One note book costs ₹ 9. How much will 22 such notebooks cost?

₹ 300

₹ 250

₹ 280

₹ 220



I cannot carry less than ₹ 9 per book.
If I carry ₹ 10 for every book,
I can quickly multiply.
 $22 \times 10 = 220$.

So, Sudha correctly ticks ₹ 220.

Do These

1. Can you estimate closest to the actual products?

- (a) There are 26 mangoes in each basket. How many mangoes will be there in 19 such baskets?

460 480 500

- (b) The cost of each movie ticket is ₹ 25. If 28 students of a class go to watch the movie, how much money they have to pay for the tickets?

₹ 800 ₹ 750 ₹ 900

- (c) Sathaiah wants to plant some trees in his field. He wants to plant in 26 rows. If each row contains 27 plants, how many plants should he buy?

600 780 900

- (d) The cost of a folding chair is ₹ 175. What is the cost of 5 such folding chairs?

₹ 500 ₹ 1000 ₹ 1500

Exercise



1. A school bag costs ₹ 75. How much will 3 such bags cost?
2. During school assembly, 15 students are standing in each row. There are 7 such rows. How many students are standing during assembly?
3. In a carton, there are 6 rows with 24 apples in each row. How many apples are there in all in the carton?
4. There are 64 bags of mangoes in an auto trolley. Each bag contains 36 mangoes. How many mangoes are there in the trolley?
5. If one litre of milk costs ₹ 60, find the cost of 85 litres of milk?
6. The length of a scale is 15 cm. The height of an electric pole is 50 times of the scale, find the height of the pole?
7. Ravi earns ₹ 175 per day. His sister earns 3 times more of Ravi's earning. How much does Ravi's sister earn in a day?

7

Equal shares and equal groups



Rajitha's father makes candles at home and sells them in the market. Rajitha helps her father in packing the candles.

On Monday father made 30 candles. He asked Rajitha to pack the candles in packets of 5. How many packets did Rajitha make?



Rajitha divided the total number of candles into groups of 5.

$$30 \div 5 = 6$$

So she made 6 packets.

- (a) If father had asked Rajitha to make packets of 6 candles each then, how many packets can she make? _____

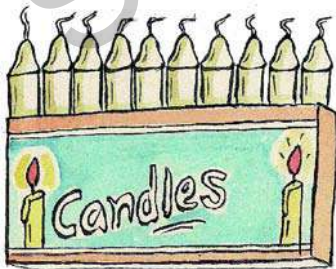

- (b) If father had asked Rajitha to make packets of 10 candles then, how many packets can she make?

On Tuesday father made 24 candles. He asked Rajitha to pack the candles equally in 3 packets.

- (c) How many candles will be there in each packet? _____



Rajitha divided the total number of candles into 3 groups.

$$24 \div 3 = 8$$

So she packed 8 candles in each packet.

- (d) If father had asked Rajitha to pack the candles equally in 8 packets then how many candles will be there in each packet? _____
- (e) If father had asked Rajitha to pack the candles equally in 12 packets then how many candles will be there in each packet? _____

Do These

- 8 people can sit safely in a jeep. If 48 people need to be taken from a village to a fair, then how many such jeeps are required?
- If 6 oranges cost ₹ 54 then how much does 1 orange cost?
- There are 42 children in a class. If an equal number of children are sitting in 7 rows, then how many children are sitting in each row?
- The product of two numbers is 56. If one number is 7, then what is the other number?

Divide and multiply

We often use multiplication when doing division.

Now write one division and one multiplication fact based on the pictures given below. One example has been done for you.

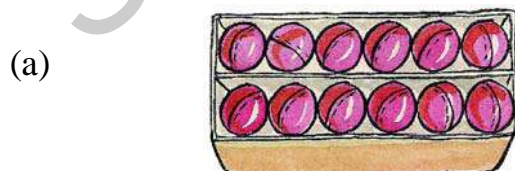

$$12 \div 2 = 6$$

$$2 \times 6 = 12$$

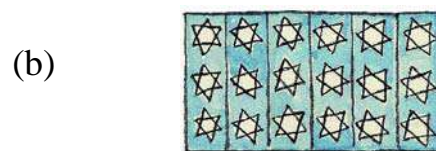

(c)

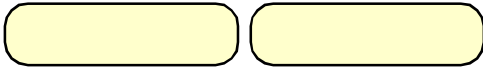

(d)

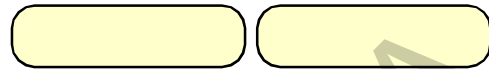
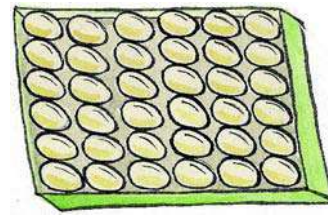

In fact we can check whether the division is correct or not by multiplying. Sudha has checked her division by multiplying like this-

$$\begin{array}{r}
 84 \div 4 \qquad \qquad \qquad 21 \text{ ————— Quotient} \\
 \text{Divisor ————} 4 \overline{) 84 \text{ ————— Dividend}} \\
 \underline{8} \\
 04 \\
 \underline{04} \\
 0
 \end{array}$$

$$\begin{array}{r}
 \text{Check} \\
 21 \\
 \times 4 \\
 \hline
 84
 \end{array}$$

So $84 \div 4 = 21$
and $21 \times 4 = 84$

Do These

1. Divide and then check by multiplying.

- (a) $75 \div 5$ (b) $84 \div 7$ (c) $96 \div 6$

2. Rajendra buys some books for ` 96. If each book costs ` 8, then how many books did Rajendra buy?

3. How many ` 5 are there in ` 95?

4. The tailor puts 6 buttons on each shirt. If he has 84 buttons, then to how many shirts can he put buttons on?



5. The product of two numbers is 77. If one number is 7, what is the other number?

6. It is 28 days to Dussera. How many weeks are there to Dussera?

7. When I am multiplied with 7, the product is 91. Who am I?

8. Make word problems of division based on the information provided in the pictures below.

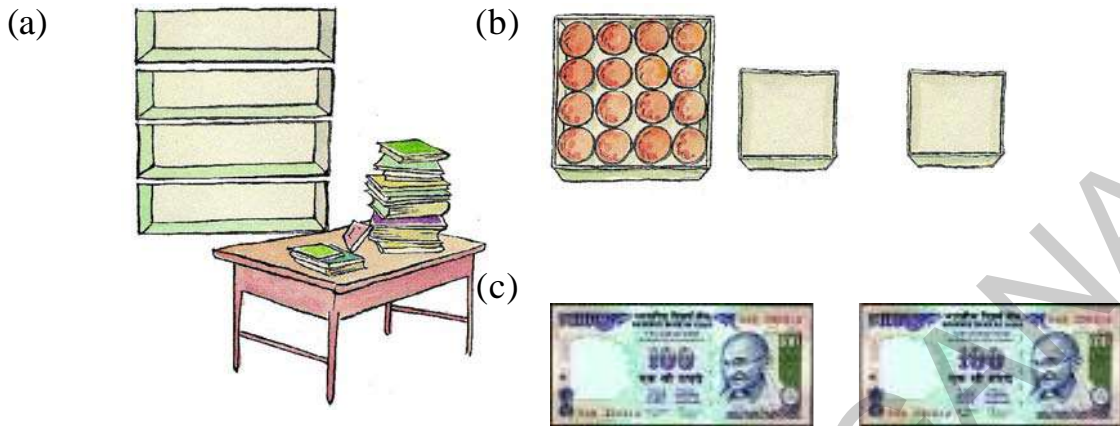

Can 7 balls be divided equally among 2 children?

When 7 balls are divided equally among 2 students, then each child will get 3 balls. One ball will remain undivided. Now let us see this division-

$$\begin{array}{r} 3 \\ 2 \overline{) 7} \\ \underline{6} \\ 1 \end{array}$$

3 is the quotient
1 is the remainder.

Now divide and find the remainder.

- (a) Divide 14 books into equal groups of four.
- (i) Number of books in each group _____
- (ii) Number of books remained undivided _____
- (b) Put 9 bulbs equally in 2 rooms.
- (i) Number of bulbs that can be fixed in each room _____
- (ii) Number of bulbs remained undivided _____



(c) Divide 15 pencils among 4 children equally.

(i) Number of pencils each child gets _____

(ii) Number of pencils remained undivided _____

Now divide 68 oranges equally among 6 people.

$$\begin{array}{r} 11 \text{ ————— Quotient} \\ 6 \overline{)68} \\ \underline{6 } \downarrow \\ 08 \\ \underline{06} \\ 02 \text{ ————— Remainder} \end{array}$$

11 is the quotient
2 is the remainder

Do These

1. Divide the following and write the quotients and remainders.

(a) $63 \div 5$ (b) $49 \div 3$ (c) $54 \div 4$

(d) $67 \div 5$ (e) $85 \div 4$ (f) $68 \div 4$

2. If one lemon costs ₹ 3, then how many lemons can be bought with ₹ 50. Will there be any money left?

3. I lie between 30 and 40. When I am divided by 5, there is a remainder of 3. Who am I?

4. If 74 apples are packed equally in 9 boxes. Then how many apples will be there in each box? How many apples will remain unpacked?

5. How many ₹ 10 are there in ₹ 93? How many ₹ 1 are left?

6. I lie between 50 and 60. When I am divided by 7, there is a remainder of 1. Then who am I?

7. The class teacher has bought 75 notebooks. If she gives each child 4 notebooks, then how many children can she distribute notebooks? How many notebooks will remain undistributed?

Dividing bigger numbers

Keshava teacher writes this problem on the board-

As usual, children did the problem differently.

$$250 \div 2$$

Vimala did it as shown below-

$$\begin{array}{r} 100 + 25 \\ 2 \overline{) 250} \\ \underline{200} \\ 50 \\ \underline{50} \\ 0 \end{array}$$

Quotient = 125
Remainder = 0

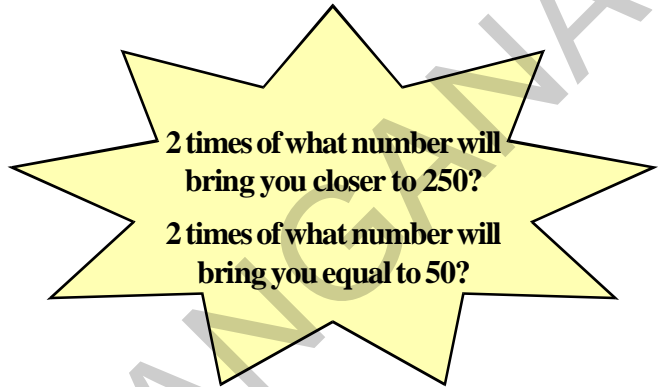

Sudha did it in this way-

$$\begin{array}{r} 125 \\ 2 \overline{) 250} \\ \underline{2} \downarrow \\ 05 \\ \underline{4} \\ 10 \\ \underline{10} \\ 0 \end{array}$$

Quotient = 125
Remainder = 0

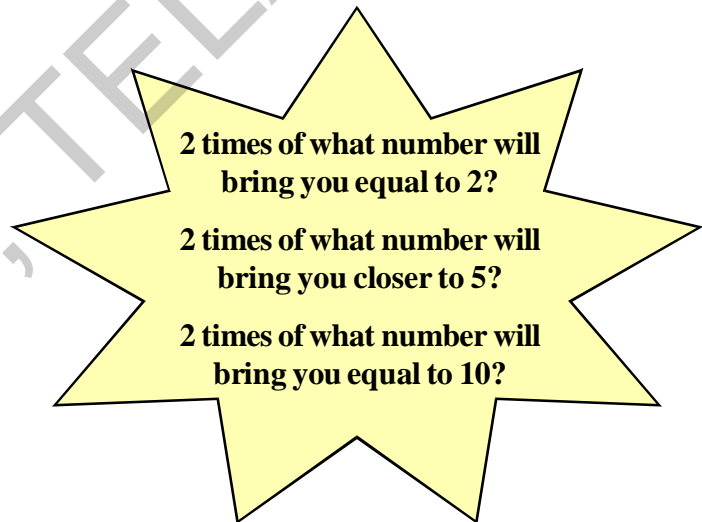

Discuss the differences in the above methods with your friends and teachers.

Keshav teacher then wrote another problem on the board

$$398 \div 4 = ?$$

As usual, children did the problem differently.

Rama did it like this-

$$\begin{array}{r} 50 + 40 + 9 \\ 4 \overline{) 398} \\ \underline{200} \\ 198 \\ \underline{160} \\ 38 \\ \underline{36} \\ 2 \end{array}$$

Quotient = 99
Remainder = 2

4 times of what number will
bring you closer to 398

Vimala did it like this-

$$\begin{array}{r} 90 + 9 \\ 4 \overline{) 398} \\ \underline{360} \\ 38 \\ \underline{36} \\ 2 \end{array}$$

Quotient = 99
Remainder = 2

4 times of what number will
bring you closer to 398

Sudha did it like this-

$$\begin{array}{r} 99 \\ 4 \overline{) 398} \\ \underline{36} \\ 38 \\ \underline{36} \\ 2 \end{array}$$

Quotient = 99
Remainder = 2

4 times of what number will
bring you closer to 39?

4 times of what number will
bring you closer to 38?

Discuss the differences in the above methods with your friends and teachers.

The teacher now wrote this problem on the board-

$$305 \div 10 = ?$$

Again children did the problem differently.

Rama did it like this-

$$\begin{array}{r} 30 \\ 10 \overline{) 305} \\ \underline{300} \\ 5 \end{array}$$

Quotient = 30
Remainder = 5

10 times of what number
will bring you closer to
305?

Sudha did it like this-

$$\begin{array}{r} 30 \\ 10 \overline{) 305} \\ \underline{30 \downarrow} \\ 5 \\ 0 \\ \underline{5} \end{array}$$

Quotient = 30
Remainder = 5

10 times of what number
will bring you closer to 3?
10 times of what number
will bring you closer to 30?
10 times of what number
will bring you closer to 5?

Kamala did it like this-

$$\begin{array}{r} 3 \\ 10 \overline{) 305} \\ \underline{30 \downarrow} \\ 5 \end{array}$$

Quotient = 3
Remainder = 5

If 305 is divided into 10
equal parts, can each part
be equal to 3?

Are all the answers correct? What was the mistake that Kamala has made?

Try This

1. Jaya has some mangoes. If she distributes, the mangoes to 2 children. She is left with none. If she distributes same mangoes to 3 children, one mango is left with her. Find the number of mangoes Jaya has?

Do not divide. Just estimate!

If ₹ 97 are to be divided equally among 5 people, about how much will each one get?

97 is close to 100 and 100 can be easily divided by 5. So each person will get about $100 \div 5 = ₹ 20$.

Now, estimate and tick the closest answer in each of the following problems.

(a) If 73 marbles have to be divided equally among 4 children, then how many marbles will each child get?

50 20 70

(b) If 92 pencils have to be divided equally among 9 children, then how many pencils will each child get?

8 10 12

(c) If 187 laddoos have to be divided in such a way that each box contains 6 laddoos, then how many boxes will be required?

20 30 40

(d) If ₹ 131 have to be divided among 7 people, then how much money will each one get?

20 15 10

(e) If ₹ 461 have to be divided among 8 people, then how much money will each one get?

50 60 70



Exercise

1. When I am multiplied by 4, the product is 48. Then who am I?
2. A car travels 96 kms in 3 hours. If it travels an equal distance every hour then how much will it travel in one hour?
3. A teacher bought 72 notebooks. She distributed 4 notebooks to each child. To how many children notebooks were distributed?

4. The product of two numbers is 72. One of the numbers is 12. What is the other number?
5. A rope is 91 m long. How many 7 m. ropes can be cut from it?
6. When I am multiplied by 9, the product is 729. Then who am I?
7. There are 648 people in 9 compartments of a train. How many people are there in each compartment?
8. 783 sarees are divided equally in 9 boxes. How many sarees will there be in each box?
9. 352 children went on a trip. If 8 children could sleep in one tent then how many tents are required for the children?
10. The weight of 7 rice bags is 350 kg. If all bags weigh the same then what is the weight of each bag?
11. How many weeks are there in a year? (Remember a year has 365 days and 7 days in a week.)
12. One apple costs ₹ 14. How many apples can be bought with ₹ 590? How much money is remaining unspent?
13. 675 apples are packed in 15 cartons. How many apples are there in each carton?
14. A boy can read 17 pages in each day. In how many days can he read 340 pages?
15. There are 105 lemon plants in 15 rows equally. How many plants are planted in each row?
16. 280 children of a school are going for a picnic. If 35 students can sit in one bus, then how many buses are needed?
17. A water tank holds 500 litres of water. How many water cans of 22 litres capacity can be filled with this water? How many litres of water will be left in the tank?

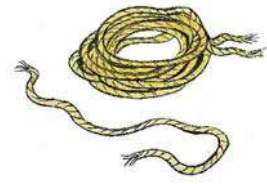

8



How long is this?

You have measured the length of pencils in class 3 using a scale. Look at your scale. How many centimetres are there on the scale? You had also learnt that we write centimetres as cm in short.

How many centimetres long is the pencil or chalk you are holding? Put it along this scale and measure its length.

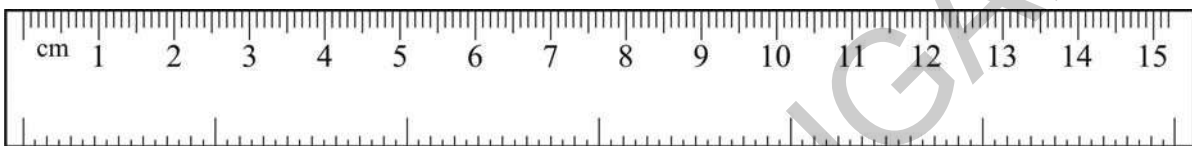

How long are the objects drawn below.

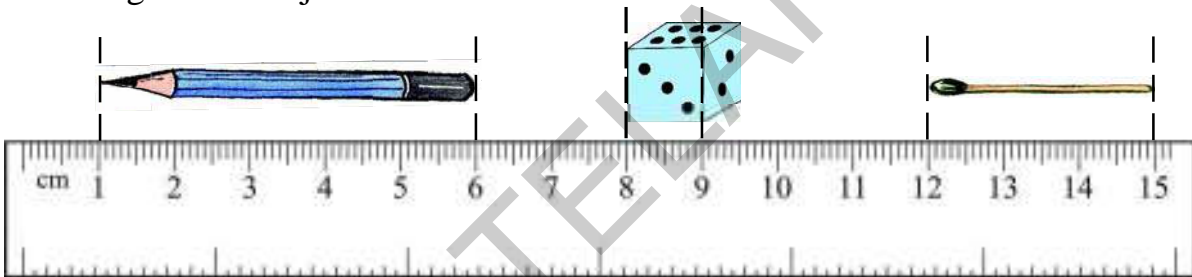

Now measure these objects again in this way.

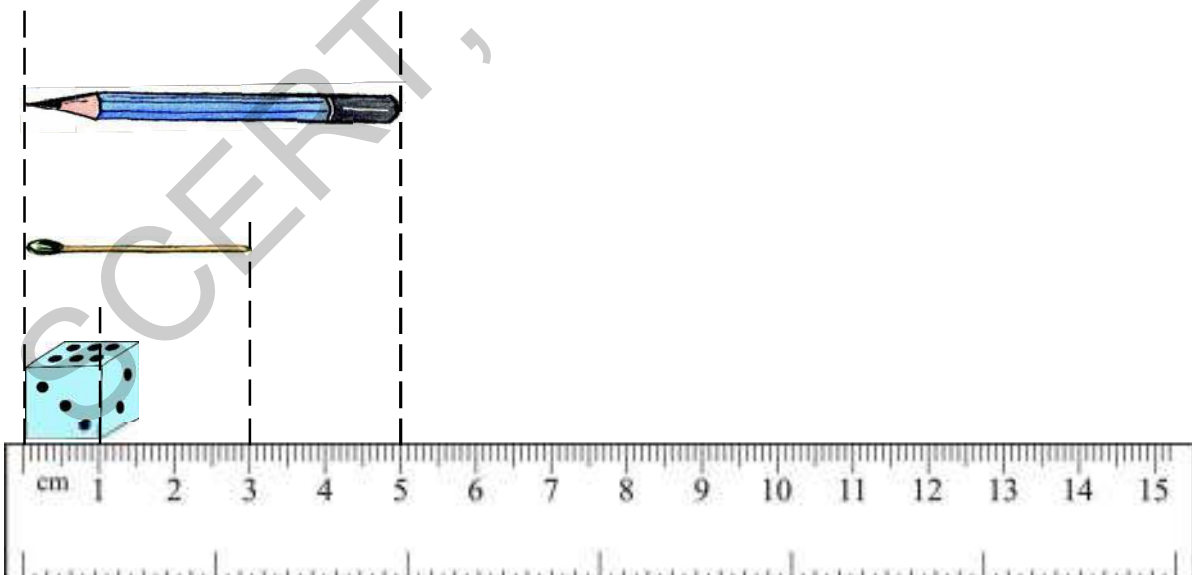

Was it easier to measure the objects in the second way? Why do you think that is easy?

Estimate the lengths and then measure them.



How long do you think your thumb is? _____ cm.

Now measure and find out how long your thumb is _____

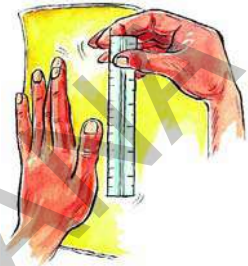

How long do you think your little finger is? _____

Now measure and find out how long your little finger is _____



What do you think is the length of your palm? _____

Now measure and find out how long your palm is _____

What do you think is the length of your wrist? _____

Now measure your wrist using a thread as shown in the figure and find out how long your wrist is _____

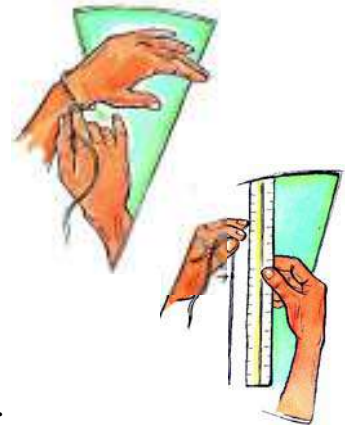

Do These

1. Name 5 things whose length is less than 1 centimetre.

.....

2. Name 3 things whose length is about 15 centimetres.

.....

3. Estimate and then measure the length of the objects given below, using a scale. Record both these lengths in the table given below.

Object	Estimated length	Measured length
A complete piece of a chalk		
Your pencil		
Your comb		
Your eraser		
Your slate		
Your mathematics book		
Your notebook		

4. Help the ant to find the shortest route to reach food.

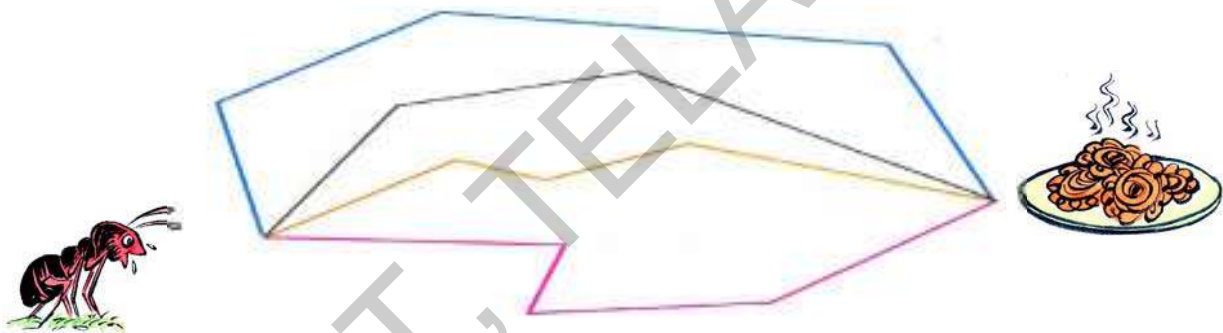

- (a) Out of the four routes, which is the shortest route the ant can take?
 (b) Can you think of a route shorter than these four routes? Draw it.

Measure your heights

Look at your scale again. On one side we have centimeters. On the other we have inches.

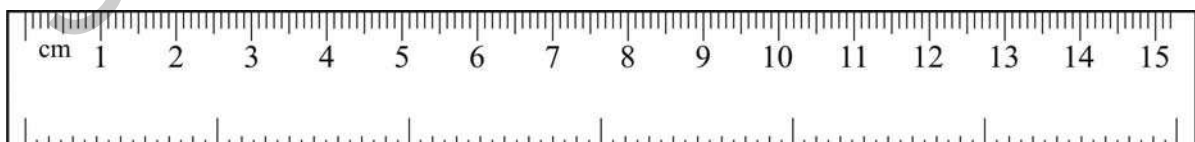

- (a) Is one inch bigger than one centimeter? _____
 (b) How many centimeters make an inch? _____

Now measure the height of three of your friends in centimetres and inches using a scale or measuring tape and write in the table below.



Name	Height (cms)	Height (inches)



From shorter lengths to longer lengths

Is it easy to measure the length of the classroom in centimetres? What about the length of cloth that you need for making clothes?

We need bigger units to measure bigger lengths easily.

Shanu went to a tailor's shop with some cloth.

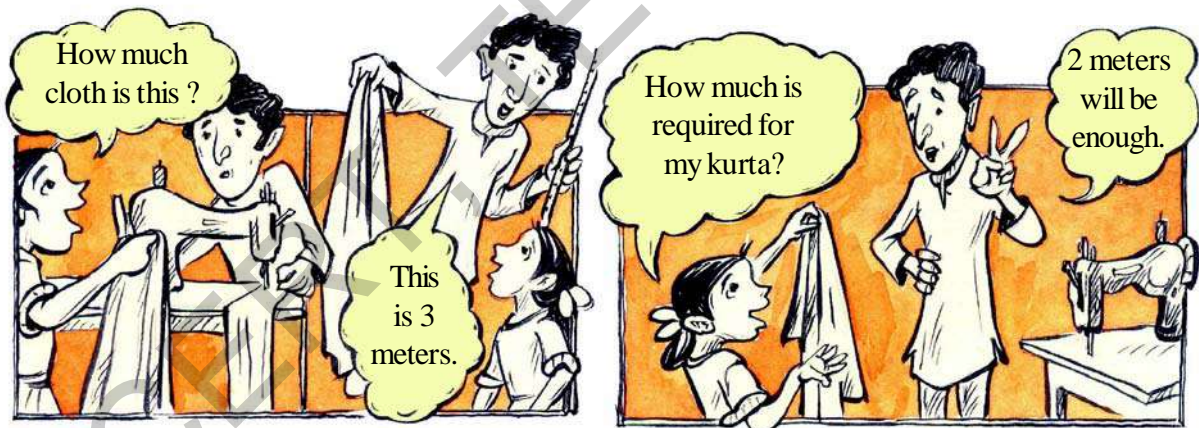

The tailor used a measuring tape to measure the length of Shanu's cloth.

Have you seen a measuring tape? It has marking of centimetres on one side and inches on the other side.

100 centimetres make a metre.

1 metre (m) = 100 centimetres (cm)

Ask your teacher to cut a metre long rope and give it to you to measure various lengths.

Activity

- Take a newspaper. Cut 20 cm, 25 cm, 50 cm and 1 m long strips from it.
 - How many of these 20 cm strips make a metre? _____
 - How many of these 25 cm strips make a metre? _____
 - How many of these 50 cm strips make a metre? _____

Are these longer than a metre?

Estimate whether these are more than a metre or less than a metre and tick the correct option. Then use a metre long rope and find their lengths. Use a scale to measure length smaller than a metre.

Object	Estimate	Measured length
Length of black board in your Classroom	More than a metre/ less than a metre	
Breadth of black board in your Classroom	More than a metre/ less than a metre	
Length of your teacher's Table Top	More than a metre/ Less than a metre	
Breadth of your teacher's Table Top	More than a metre/ Less than a metre	
Length of your classroom window	More than a metre/ Less than a metre	
Breadth of your classroom window	More than a metre/ Less than a metre	

Do These

- Name 5 things that are about a metre long.
- What is the length of your classroom? What is its breadth?
Measure using the metre rope and check your estimate.

3. Which of the following would you measure in metre and which would you measure in centimetre?

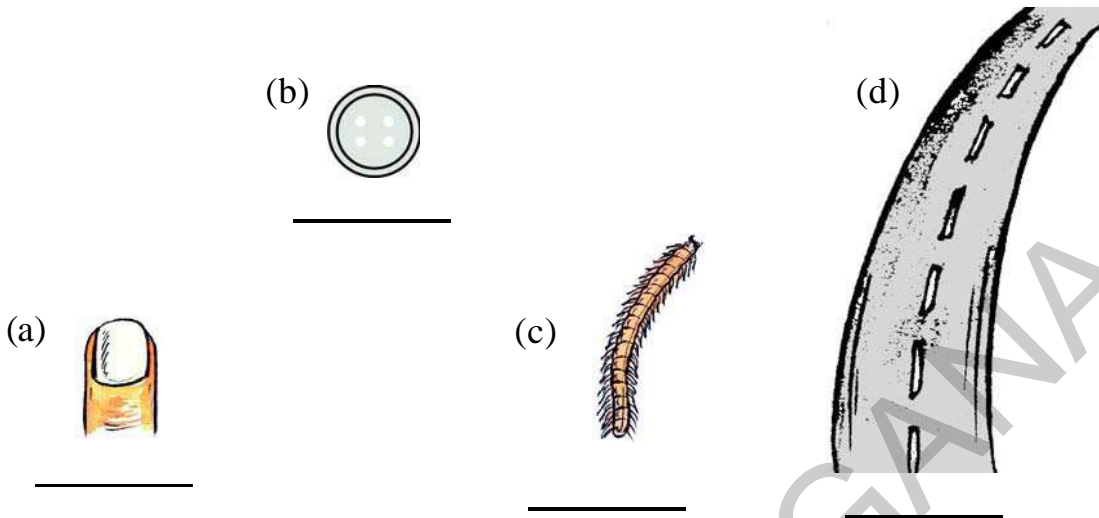

Sports Day

On sports day the school has organized a 100 metres race for class 4 children. Saraswathi is nearest to the finishing line. She is 6 metres away from the finishing point. Durga is in second place and Mahadev is behind her.



Estimate

- (a) About how many metres is Durga away from Saraswathi?
- (b) About how many metres is Mahadev away from the finishing line?

How far do they live from each other?

Ram and George live in opposite directions from their school.

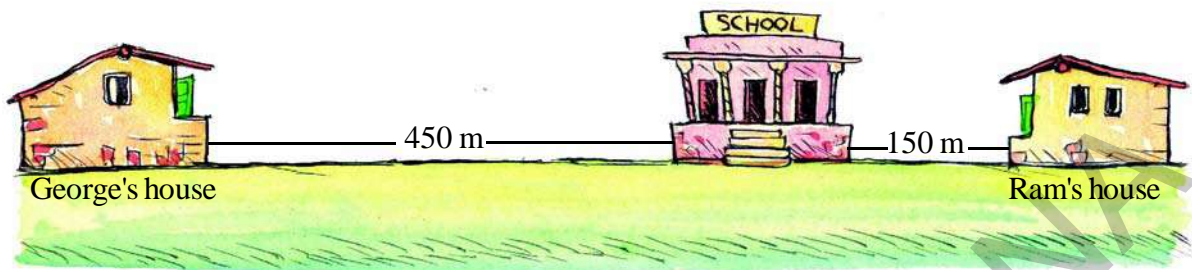

- (a) What is the distance between Ram's house and George's house?

Javelin Throw

The Olympic Games 2012 were held in London. The details of the women who got the gold, silver and bronze medal in the game of Javelin Throw are given below-

Medal	Name	Country	Length of throw
Gold	Barbora Spotakova	Czech Republic	69m 55 cm
Silver	Christina Obergfoll	Germany	65m 16 cm
Bronze	Linda Stahl	Germany	64m 91cm

- (a) What is the difference in Barbora's and Christina's length of throw?
- (b) What is the difference in Barbora and Linda's length of throw?
- (c) The world record for Javelin Throw is 72m 28cm and is also held by Barbora Spotakova. How many metres Barbora is short of her world record at the London Olympics?



Try This

1. How high is the Charminar?

The height of the historical construction, Charminar in Hyderabad is 56 m.

What is the height of your school building?

How many of your school buildings, if placed one on top of the other, will be as high as the Charminar?



Exercise



- 4 m of ribbon = _____ cm of ribbon.
 - 9 m of pipe = _____ cm of pipe.
 - 450 cm of cloth = _____ m _____ cm of cloth.
 - 750 cm of rope = _____ m _____ cm of rope.
- I went to shop and bought 2 m 50 cm cloth for my kurta and 3 m 75cm cloth for my pajama. What is the total length of cloth that I bought?
- The length of the shadow of a flag pole is 3 meter 45 centimetres at 8 o'clock in the morning. By 1 o'clock in the afternoon it is 1 metre 65 cm. What is the difference in the length of the shadow in the morning and in the afternoon?
- Kannaiah bought 12 m 50 cm of Mangalgiri cotton cloth and 10 m 25 cm of Pochampalli cotton cloth for making curtains, from a shop. What is the total length of the cloth he bought?
- A tailor had 4 m 45cm of cloth. He cut off 3m 95 cm of the cloth to stitch a pair of trousers. What is the length of cloth that is left?
- Prasad bought 20 meters of rope. He used 12 m 30 cm of rope to tie one clothes line and 7 m 45 cm to tie another clothes line. What is the total length of rope that he used? What is the length of rope left with him?
- A cloth merchant bought a roll of Pochampalli cotton of length 140 m. He sold 46 m 85 cm of the cloth. How much cloth is left in the roll?

8. Head mistress Jaya bought a ribbon of length 18m. If she gives each girl a ribbon of length 25 cm. To how many girls can she distribute ribbon?

9. **Shot put**

At the Olympic Games in London, the details of the women who got the gold, silver and bronze medal in the game of shot put are given below.



Medal	Name	Country	Length of throw
Gold	Valarie Adams	New Zealand	20m 70 cm
Silver	Yergeniya Kolodko	Germany	20m 48 cm
Bronze	Gong Lijiao	Germany	20m 22cm

- (a) What is the difference in Valarie and Gong's length of throw?
- (b) To compete in this game, the participants were required to throw the 'put' to the qualifying limit of 18 m 90 cm away. How much farther did Valarie throw the 'put' than the qualifying limit?
- (c) The world record for shot put throw is 22 m 63 cm and is held by Natalya Lisovskaya. Yergeniya is how many metres short of this world record?

9

How much does it weigh?

Have you ever picked up a sack of rice? Did you find it difficult? Why?

Which is heavier- a sack of rice or a packet of rice?

How much do you think the rice packet weighs?

How much do you think the sack of rice weighs?

We had learnt in Class 3 that we measure weight in kilograms. We also learnt that we can write kilogram as kg.

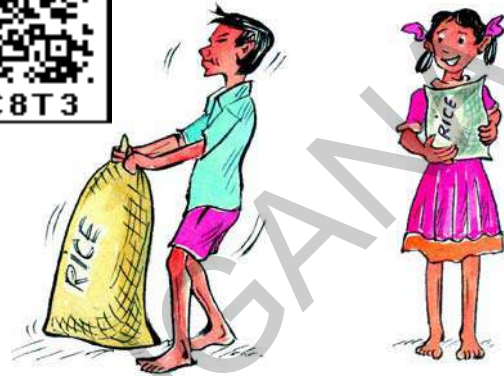

You can find 1 kg, 2 kg, 5 kg and 10 kg weights in a grocer's shop. You will find heavier weights-50 kg, 20 kg in other shops like those that grind wheat, maize etc. or make mattresses and pillows.

Why do you think these shops need heavier weights?

Try This

Pick up as many weights as you can and find out how heavy they are. Also make 1 kg, 2 kg and 5 kg weights by filling packets with sand or mud, with the help of your teacher. Pick them up to find out how heavy they are.

Let us estimate their weight.

1. Encircle the objects which you feel are heavier than one kilogram.



2. Encircle the objects that weigh about 10 kilograms.



3. Estimate their weights and match appropriately.

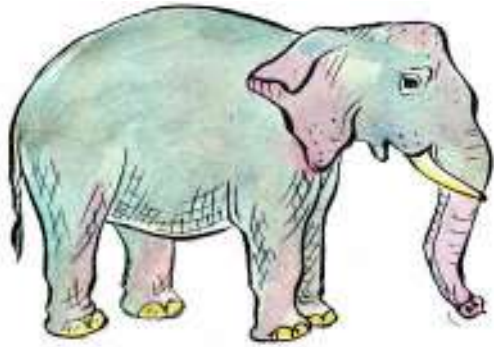

less than 1 kg



15 kg



more than 1000 kg



300 kg



30 kg

How much weight is this truck carrying?

Rajendra and Padma are shifting their residence from Miryalaguda to Hyderabad. The truck is loaded with their luggage. The weight of each luggage is given below.



Luggage	Weight
Bed	45 kg
Refrigerator	60 kg
TV	15 kg
Utensils	10 kg
3 Suitcases	60 kg
Table	10 kg
3 chairs	15 kg
Almirah	30 kg

- (a) How much weight is the truck carrying? _____
- (b) If Rajendra and Padma are paying ₹ 20 for every kilogram of luggage, how much money will they pay to the truck company? _____

How heavy are these mattresses and pillows?

Sultana makes mattresses and pillows by filling them up with cotton. She has 145 kgs of cotton lying in her shop.

Raghu asks her to make one mattress and two pillows. Sultana used 20 kgs of cotton in the mattress and 2 kgs of cotton in each of the pillows.

- How much cotton will be left with Sultana after she makes the mattress and the pillows? _____
- How many such mattresses can Sultana make from the cotton left with her? _____
- Sultana charges ` 15 for every kg of cotton she has used. She also charged ` 200 for sewing the mattress and pillows and another ` 125 for the cloth she has used. What is the total amount that Raghu has to pay her? _____



From kilograms to grams

Things that are lighter than one kilogram are measured in grams. You may have come across 500 gm, 200 gm, 100 gm, 50 gm, 20 gm, 10 gm weights at the grocer's shop. Some are shown below.



$$1 \text{ kg} = 1000 \text{ gm}$$

Pick up each of these weights and find out how heavy they are.

How much do you think a pencil weighs?

A pencil weighs about 3 grams.



Let us Estimate their weight.

1. Encircle the names of objects that are heavier than a pencil.

Pin Spoon A tamarind seed Cup Ant A piece of chalk

Activity

Go to a grocer's shop. Pick up things which have their weights written on their packets and fill the table given below-

Things that weigh about 50 gm	Things that weigh about 150 gm	Things that weigh about 250 gm	Things that weigh about 500 gm	Things that weigh about 1 kg

In how many ways can Mary purchase 1 kg of washing powder?



One day Mary went to a shop to buy washing powder. The shop keeper told Mary that he only kept washing powder in packets of 250 gm, 100 gm and 500 gm.

Mary remembered what her teacher had taught her.

In how many ways can Mary buy 1kg of soap powder? One has been done for you.

(i) $1\text{kg} = 1000\text{ gm} = 500\text{ gm} + 500\text{ gm}$

Mary can buy 2 packets of 500 gm each.

Try This

Kamal uses 2 kg, 5 kg and 6 kg stones to weigh the waste newspaper brought to his shop. How will he weigh newspaper loads that weigh 1 kg, 3 kg, 4 kg and 7 kg with these stones?



At the post office

Have you ever been to a post office?

We go to a post office to send letters and parcels to our friends and family who live far away from us.

The table given below tells you how much it costs to send letters and parcels within our country-



Item	Rate (as per weight)
Letter	₹ 5 (for every 20 grams or less)
Parcel	₹ 19 (for the first 500 grams) ₹ 16 (for every 500 grams after)



- (a) Radha has written a long letter to her friend. The post master tells her that her letter weighs 45 grams. How much money will Radha have to pay to the post master?
- (b) Radha is sending three Pochampalli sarees to her friend in Udaipur. The parcel weighs 2kg 500gm. How much money should Radha pay to the postmaster?

Various ways of measuring weight

These days various types of electronic devices are used to measure weight.



Do These



Use a weighing machine and find out your weight and that of four of your friends. Record your findings in the table given below.



Name	Weight

Try This

1. Which is heavier - one kg of cotton or one kg of iron?

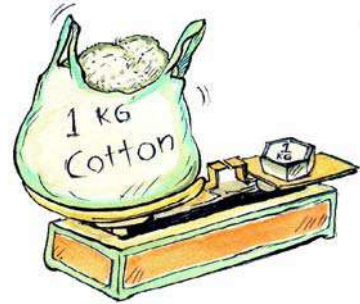

Exercise

1. Kalyan bought the following items mentioned in his grocery bill. Estimate whether weight of each item is in grams or kilograms.

Item	Weight	kg/ g
Rice	10	
Sugar	2	
Dal	500	
Haldi	250	
Tea Powder	200	
Mustard Seeds	25	

2. Name 5 things we usually buy in kilograms and 5 things we usually buy in grams.
3. During pongal 20 kg of rice was made in Latha's house. 8 kg 500 gm was consumed by family members and friends. The rest was distributed among the poor. How much rice was distributed among the poor?
4. A boat can carry 200 kg weight. If the weight of people in the boat is 112 kg, how much more weight can the boat carry?
5. Mahesh weighs 78 kg and Ramesh weighs 95 kg. How much more does Ramesh weigh than Mahesh?
6. My weight is 22 kg. My father's weight is 3 times my weight. What is my father's weight?

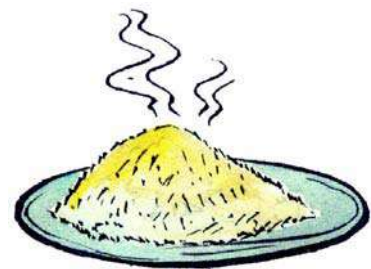

7. An auto trolley is carrying gas cylinders of 700 kg weight. A full gas cylinder weighs about 35 kg. How many such gas cylinders are there in it?



8. A motor cycle weighs 200 kgs. If a jeep's weight is 9 times more of the motor cycle, what is the weight of the jeep?

9. Fill in the blanks given below-

- (a) 4 kg of rice = _____ gm of rice
 (b) 2 kg 500 gm of dal = _____ gm of dal
 (c) 6 kg 500 gm of sugar = _____ gm of sugar
 (d) 1250 gm of onions = 1 kg 250 gm of onions
 (e) 1750 gm of tomatoes = _____ kg _____ gm of tomatoes
 (f) 2550 gm of potatoes = _____ kg _____ gm of potatoes

10. Estimate weights and then compare with actual weight.

Item	Estimated Weight	Actual Weight	Difference
Puppy (pet dog)			
Your school bag			
Your brother/sister			
Geometry box			
1 litre water bottle (Full)			
Necklace			

10 How much do these bottles hold?

We have learnt in class 3 that a bottle holds 1 litre of water.

How many glasses of water will fill a 1 litre water bottle? _____

Which of the containers given below holds more than a litre and which holds less than a litre? Write in the table below. In the same way elongate the list of objects.



More than a litre	Less than a litre

Estimate how many litres these containers can hold?

- 1000 litres 1 litre 20 litres Half a litre Less than half a litre

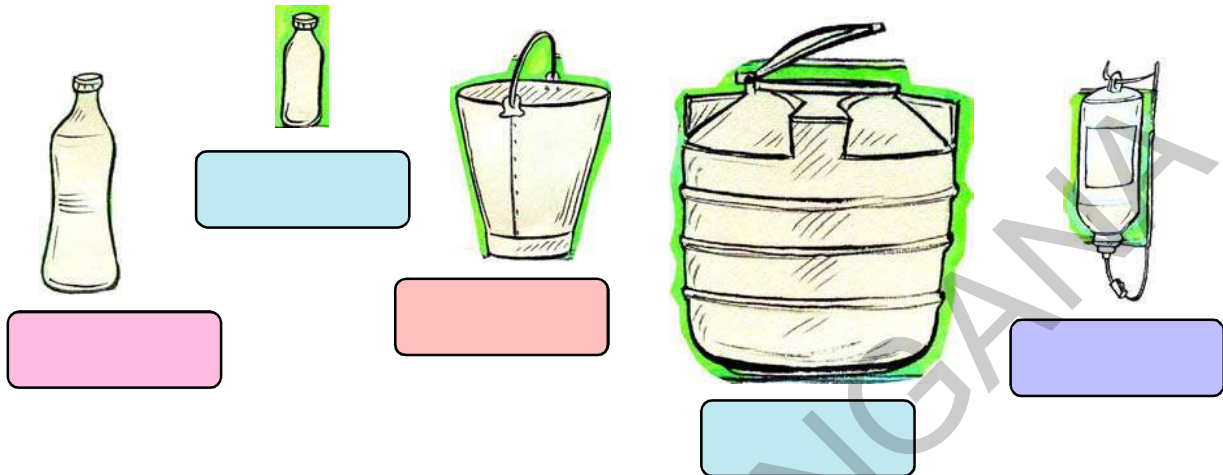

How much water does Dolly use in a day?

Dolly uses a bucket of water for having bath. She drinks about 8 glasses of water and uses 3 buckets of water for other purposes in a day. How many litres of water does Dolly need for.

- (a) having bath _____
- (b) drinking _____
- (c) for other purposes _____

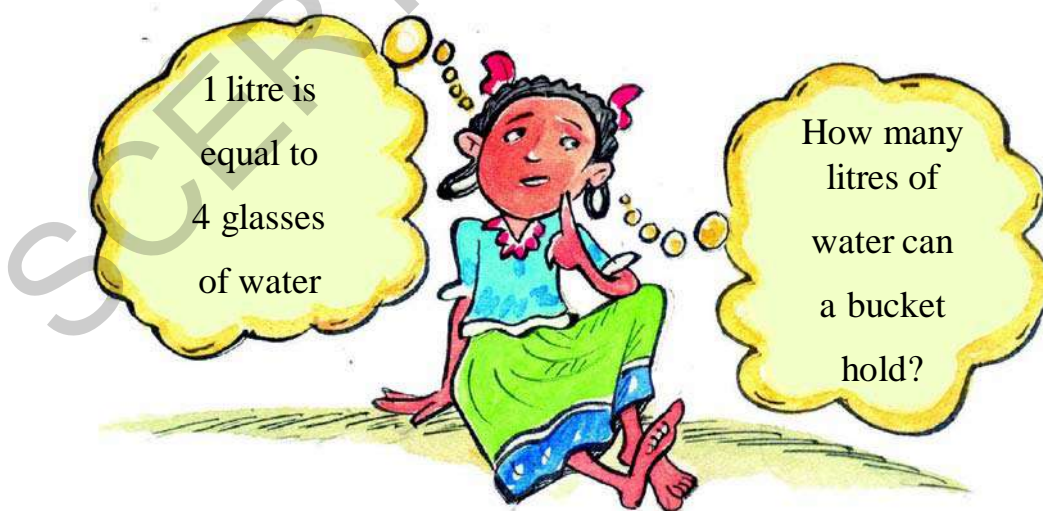

- (d) How many litres of water does dolly need in a day? _____

Try This

Estimate how many litres of water you use daily?

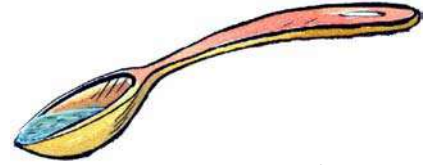

Less than a litre

How much liquid can a spoon hold?

A spoon can hold about 3 millilitres of liquid.

You think of things that you take in such small quantities and write below.

We write millilitres
as ml also

Let's go to a doctor

Chitra cut her hand while sliding down the swing. Her parents immediately took her to the doctor for a tetanus injection. Chitra was not scared of injections. She asked the doctor to show her the medicine filled in syringe.

How much medicine is there in the syringe?

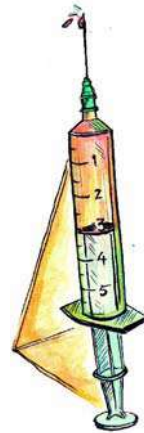

The doctor prescribed Chitra a tonic also and asked her to take 5 ml each time. He showed her the 5 ml marking on the cap.

Do These

Which of the following things do you take in millilitres and which in litres?

Item	Millilitres/ Litres
Milk	
Coconut oil	
Cool drink	
Shampoo	
Medicine syrup	

A thousand millilitres make a litre.

Vasudha took an empty 1 litre water bottle and an empty 250 ml coconut oil bottle.



She filled the coconut oil bottle completely with water and poured it into the water bottle.



She then filled the coconut oil bottle with water again and poured it into the water bottle.

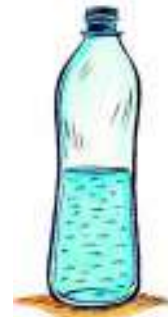

She repeated this two more times and her 1 litre bottle was completely filled up.

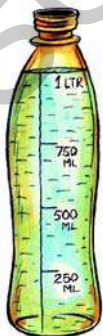

Thus, $250 \text{ ml} + 250 \text{ ml} + 250 \text{ ml} + 250 \text{ ml} = 1000 \text{ ml}$

Do These

How many of these will be needed to make a litre?









Activity

Collect three bottles of different sizes. Estimate, how many bottles of each type would fill a 1 litre bottle. Then find out how correct your estimate is by pouring water from each of these bottles into a one litre bottle.

	Your estimate	Your measurement
Bottle 1		
Bottle 2		
Bottle 3		

- (a) If two small bottles fill up a one litre bottle, then how much would each small bottle hold?



- (b) If four small bottles fill up a one litre bottle, then how much would each small bottle hold?

Try This

1. Fill in the blanks given below and make it equal to 1 litre.

(a) $500 \text{ ml} + \underline{\hspace{2cm}} = 1 \text{ litre.}$

(b) $\underline{\hspace{2cm}} + 750 \text{ ml} = 1 \text{ litre.}$

(c) $900 \text{ ml} + \underline{\hspace{2cm}} = 1 \text{ litre.}$

(d) $\underline{\hspace{2cm}} \times 500 \text{ ml} = 1 \text{ litre.}$

(e) $\underline{\hspace{2cm}} \times 250 \text{ ml} = 1 \text{ litre.}$

Let's save water!

Is there a tap in your home, school or surroundings from which water is leaking?

Put a one litre bottle under it and find out how much water fills in one hour.

(a) If the tap was to continue leaking for one day, how much water would be wasted?

(b) If the tap was to continue leaking for one week, how much water would be wasted? _____



Exercise

1. Fill in the blanks given below.

(a) $3 \text{ litres} = \underline{\hspace{2cm}} \text{ ml}$

(b) $7 \text{ litres} = \underline{\hspace{2cm}} \text{ ml}$

(c) $8500 \text{ ml} = \underline{\hspace{2cm}} \text{ l } \underline{\hspace{2cm}} \text{ ml}$

(d) $5250 \text{ ml} = \underline{\hspace{2cm}} \text{ l } \underline{\hspace{2cm}} \text{ ml}$

(e) $9750 \text{ ml} = \underline{\hspace{2cm}} \text{ l } \underline{\hspace{2cm}} \text{ ml}$



2. What is the total amount of water in the bottles?



3. Kalpana's cow gives 15 litres of milk every day. If Kalpana uses 8 litre 500 ml of milk at home, how much can she sell in the market?
4. A water tank holds 500 litres of water. The school uses 375 litres of water in a day. How much water is left for the next day? If the school needs a full tank the next day, how much more water needs to be pumped into the tank?
5. Anand drinks 250 ml and Anitha drinks 500 ml of milk everyday. If they drink the same amount of milk every day, how much of milk will they drink in 4 days? How much milk will they drink in 7 days?
6. How much water do you take everyday? How much milk? How much tea? How much juice? If 4 glasses of liquid is equal to 1 litre, then how many litres of liquid do you have in a day and in a month?
7. Swathi has to pour out 2 litres of juice in glasses that can hold 200 ml. How many such glasses are required?
8. Karuna's two year old daughter was ill. The doctor asked Karuna to give her daughter 3 ml of a tonic medicine, 3 times a day. He asked Karuna to continue the medicine for 7 days.
- (a) How much medicine will Karuna's daughter take in 7 days?
- (b) If the tonic bottle contains 100 ml of medicine, then how much medicine will be left in the bottle after 7 days?
9. A tonic bottle contains 60 ml of medicine. How much medicine will be there in 15 such bottles?

10. Mahesh runs a tea shop. He uses about 20 ml of milk in each tea cup. If he sells 50 cups in a day, how much milk does he use in a day?
11. A shopkeeper keeps different sized coconut oil bottles in her shop. In a day she sells 60 bottles of oil. The details are given below-

Sale per day	Capacity per bottle
20 bottles	200 ml
30 bottles	500 ml
10 bottles	100 ml



How much oil does the shopkeeper sell in the day?

12. Rajendra and Rajni and their two children live in Adilabad. The table given below gives details about the water used by the family in a day.

Usage	Number of litres
Cooking and drinking water	15 litres
Washing utensils	20 litres
Washing clothes	40 litres
Taking bath	60 litres

- How much water does the family use in a day?
13. Estimate how much water your family uses in a day and write in the table below-

Usage	Number of litres
Cooking and drinking water	
Washing utensils	
Washing clothes	
Taking bath	

11

Tick - Tock goes the clock

How much time does it take for you to draw a flower? How much time do you take to take a bath? How much time do you spend in school? Find out how much time a basket maker takes to make a basket? How much time does a carpenter take to make a chair? How much time does a tailor take to make a kurta?



Different activities require different amounts of time. Think of various activities and fill the table given below.

Activities that require a few minutes	Activities that require hours	Activities that require days	Activities that require months
Taking a bath	Studying at school	Building a hut	Growing rice

How much time does it take you to wink? Think of other activities that require less than a minute of your time? _____

Let's see a movie!

Surya is very excited today. Today is the last day of his exams and his parents promised him that they would be going to watch a movie in the evening.



(a) He reaches his school at _____



(b) He started writing his exam at _____



He had 2 hours to write the exam. While writing the exam he looked at the clock in his classroom to see how much time was left.

(c) How much time did Surya have? _____

Surya finished writing his exam a few minutes before 12 o'clock and then he walked back home. After coming back from school he kept looking at the clock.

(d) What is the time in the clock now? _____



(e) Surya thought that they would leave after 3 hours for movie. At what time will Surya leave his house? Which of the clocks given below is showing this time? Encircle it.



Do These

- (a) What is the time on the clock? _____
(b) What was the time 5 hours ago? _____
(c) What will be the time after 4 hours? _____

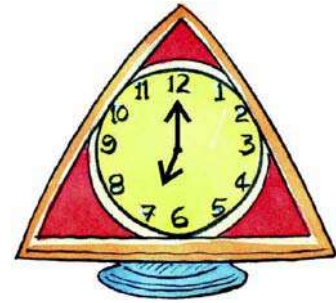

- (a) What is the time on the clock? _____
(b) What was the time 3 hours ago? _____
(c) What will be the time after 2 hours? _____

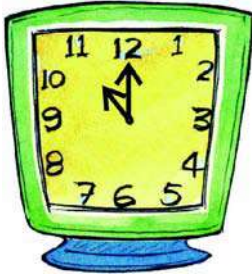

Bunty on a morning!

Bunty is late to school. He looks at the clock while going to take a bath hurriedly. What is the time on the clock?



After having bath, Bunty looks at watch again and finds that the longer hand has moved to 3.

Bunty remembers his teacher telling him how to read the clock.



The smaller hand tells you the hour and the longer hand of the clock tells you the minutes. When the longer hand is at 1 it means 5 minutes have passed. When the hand is at 2, it means 10 minutes have passed. When it is at 3 it means 15 minutes have passed and when it is at 4 it means 20 minutes have passed and so on. How many minutes would have passed when the minutes hand is at 7? How many minutes would have passed when the minutes hand has completed one full circle and is at 12. So tell, how many minutes are there in an hour?



Bunty : It is eight fifteen. I must hurry.

He quickly puts on his clothes and gobbles up the roti his mother gives him. He looks at the clock again while leaving home.

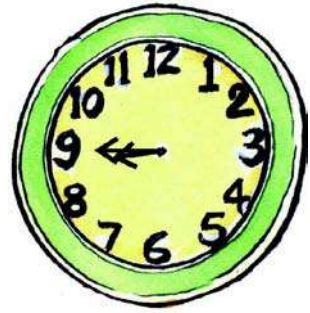

It is eight forty five. I will not reach school on time.

- (a) Bunty reached school 15 minutes late. At what time would Bunty have reached school? _____

Do These

1. Which of these clocks is telling the correct time? Encircle it.

- (a) 2:05

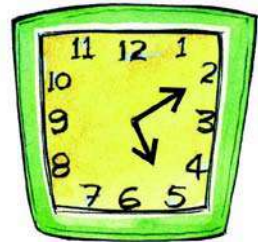
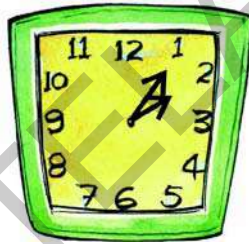
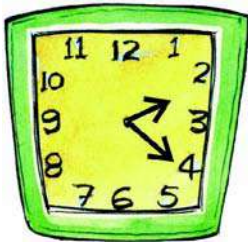

- (b) 4:15



- (c) 7:25



2. What is the time on these clocks?

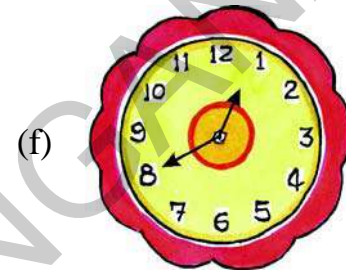
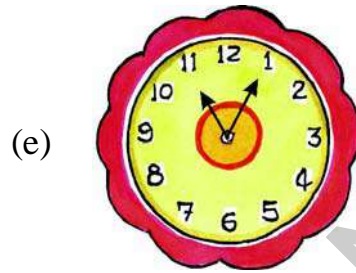
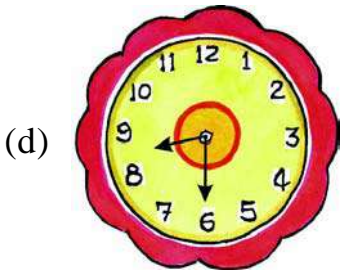
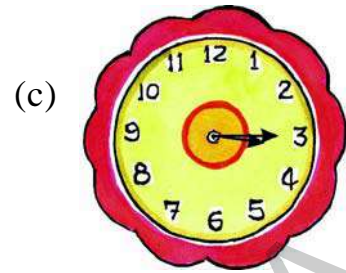
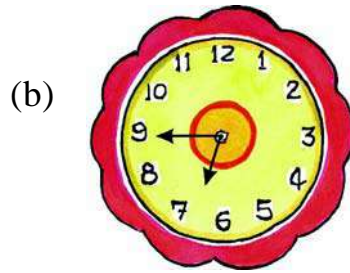
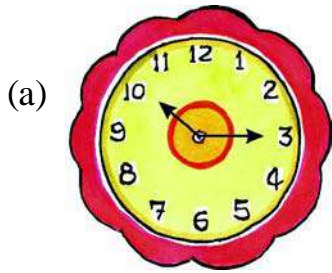

3. Show the time on these clocks.

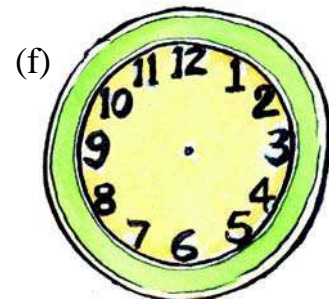
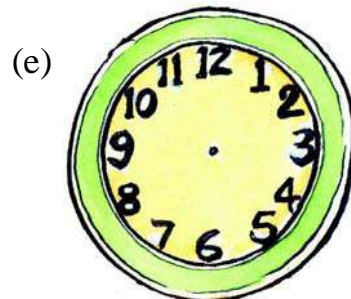
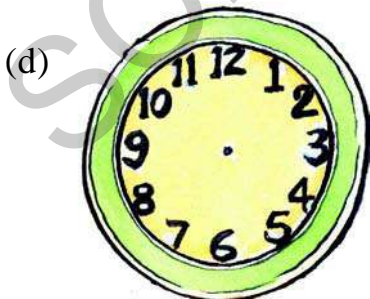
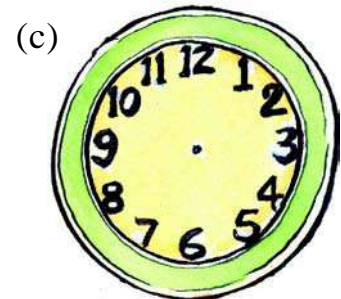
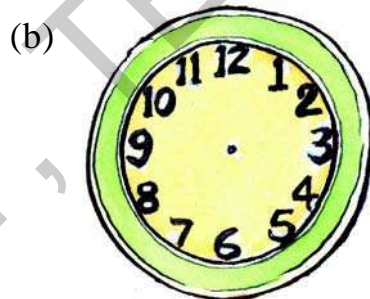
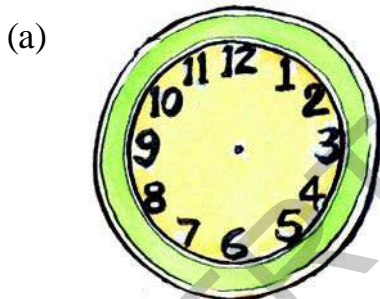

Try This

- Does the hour hand move as the hour passes? How many minutes does the hour hand take for moving from one number to the other?
- At what time do the minute and hour hands coincide with each other between
 - 6 o'clock and 7 o'clock _____
 - 9 o'clock and 10 o'clock _____
 - 3 o'clock and 4 o'clock _____
 - 12 o'clock and 1 o'clock _____

Now that we have learnt to read the clock. Let us read the calendar

Jaya teacher wanted to talk to her children of class 4 about the calendar-2012. She gave each child in the class a list of the festivals in the year, which had been declared as school holidays.

She then asked them to look at the calendar in their class to see whether the holidays declared were on a school working day or a Sunday.

- Encircle the festival days on the calendar and also write which day of the week they are on in the space given below. Do any of the festivals fall on a Sunday?

Festival	Date	Day
Diwali	13 November	
Pongal	14 January	
Guru Nanak Jayanthi	17 November	
Christmas	25 December	
Eid	9 August	
Holi	27 March	

- Write the list of these festivals in the order in which they occur in the year in your notebook?

CALENDAR-2013

January

S	M	T	W	Th	F	Sa
		1	2	3	4	5
6	7	8	9	10	11	12
13	14	15	16	17	18	19
20	21	22	23	24	25	26
27	28	29	30	31		

February

S	M	T	W	Th	F	Sa
					1	2
3	4	5	6	7	8	9
10	11	12	13	14	15	16
17	18	19	20	21	22	23
24	25	26	27	28		

March

S	M	T	W	Th	F	Sa
					1	2
3	4	5	6	7	8	9
10	11	12	13	14	15	16
17	18	19	20	21	22	23
24	25	26	27	28	29	30
31						

April

S	M	T	W	Th	F	Sa
	1	2	3	4	5	6
7	8	9	10	11	12	13
14	15	16	17	18	19	20
21	22	23	24	25	26	27
28	29	30				

May

S	M	T	W	Th	F	Sa
			1	2	3	4
5	6	7	8	9	10	11
12	13	14	15	16	17	18
19	20	21	22	23	24	25
26	27	28	29	30	31	

June

S	M	T	W	Th	F	Sa
						1
2	3	4	5	6	7	8
9	10	11	12	13	14	15
16	17	18	19	20	21	22
23	24	25	26	27	28	29
30						

July

S	M	T	W	Th	F	Sa
	1	2	3	4	5	6
7	8	9	10	11	12	13
14	15	16	17	18	19	20
21	22	23	24	25	26	27
28	29	30	31			

August

S	M	T	W	Th	F	Sa
				1	2	3
4	5	6	7	8	9	10
11	12	13	14	15	16	17
18	19	20	21	22	23	24
25	26	27	28	29	30	31

September

S	M	T	W	Th	F	Sa
1	2	3	4	5	6	7
8	9	10	11	12	13	14
15	16	17	18	19	20	21
22	23	24	25	26	27	28
29	30					

October

S	M	T	W	Th	F	Sa
		1	2	3	4	5
6	7	8	9	10	11	12
13	14	15	16	17	18	19
20	21	22	23	24	25	26
27	28	29	30	31		

November

S	M	T	W	Th	F	Sa
					1	2
3	4	5	6	7	8	9
10	11	12	13	14	15	16
17	18	19	20	21	22	23
24	25	26	27	28	29	30

December

S	M	T	W	Th	F	Sa
1	2	3	4	5	6	7
8	9	10	11	12	13	14
15	16	17	18	19	20	21
22	23	24	25	26	27	28
29	30	31				

Jaya teacher then started asking children various questions about the 2013 calendar. Do you know the answers to these questions?

- (a) How many months are there in a year? _____
- (b) Add the number of days of all the months to find out how many days there are in a year. _____
- (c) Which month comes after May? _____
Which month comes before December? _____
- (d) (i) How many Thursdays are there in March? _____
what dates do they occur on? _____
- (ii) How many Sundays are there in March? _____
what dates do they occur on? _____
- (e) Encircle the following dates in the calendar and write what day they occur on.
- (i) Republic day 26 January _____
- (ii) Children's day 14 November _____
- (iii) Independence day 15 August _____
- (f) If 31st December falls on Monday, which day will 1st January of next year fall on? What will be the date on the next Monday? _____
- (g) Is the first of every month, the same day? _____
- (h) (i) Which year calendar is given? _____
- (ii) Which is the next year? Which was the year before this year? _____
- (iii) In which year were you in class 1? _____
- (i) Study the calendar of February 2012.
- (i) How many days are there in February, 2012? _____
- (ii) How many days are there in February, 2013? _____
- (iii) How many days are there in February, 2014? _____
- (iv) Find out the next year in which February will have 29 days. _____

February-2012

S	M	T	W	Th	F	Sa
			1	2	3	4
5	6	7	8	9	10	11
12	13	14	15	16	17	18
19	20	21	22	23	24	25
26	27	28	29			

2012 is called a leap year because February has 29 days instead of 28. Leap year comes once in 4 years.

May 2014

- How many days are there in the month? _____
- How many Thursdays are there in the month?

- How many Sundays are there in the month? _____
- Can you have a month with 6 Mondays? Why?

May-2014

S	M	T	W	Th	F	Sa
				1	2	3
4	5	6	7	8	9	10
11	12	13	14	15	16	17
18	19	20	21	22	23	24
25	26	27	28	29	30	31

June-2014

- | S | M | T | W | Th | F | Sa |
|---|---|---|---|----|---|----|
| | | | | | | |
| | | | | | | |
| | | | | | | |
| | | | | | | |
| | | | | | | |

Now make the calendar for the next month.



Exercise

- Omar is 9 years old. His father is 4 times his age. How old is Omar's father?
- Sunanda went to her friends house at 5:15 in the evening. She came back home at 7:30 in the evening. How much time has Sunanda spent to play with her friends?
- Girish went to the field at 7:15 in the morning. He came back home at 1:45 in the afternoon. How much time has Girish spent in the field?
- Santosh's family and friends were in a picnic from 10:30 in the morning to 4:20 in the evening. How much time did Santosh and his family spend at the picnic?
- Look at the clocks given below. Mention the time.









Dividing into equal parts

Mother has put 12 idlis on the plate.

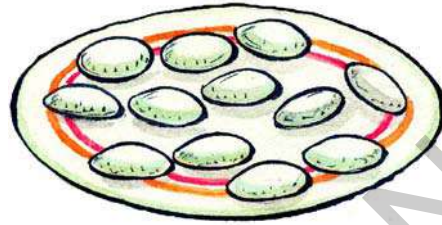

Mother : Sonu and Koushik divide these idlis equally between both of you and finish your breakfast.

Sonu and Koushik divided them like this.

Have they divided the idlis equally?



Now, can you divide these 8 idlis equally among 4 children?

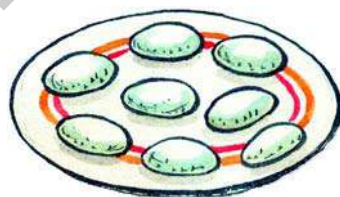

Also, divide these 9 pencils equally among 3 children?



What about, 16 marbles among 4 children?



Today the maths teacher is teaching division in class. She makes 12 pencils on the board and asks Sonu to divide 12 pencils among 3 people. Sonu divides by drawing circles.

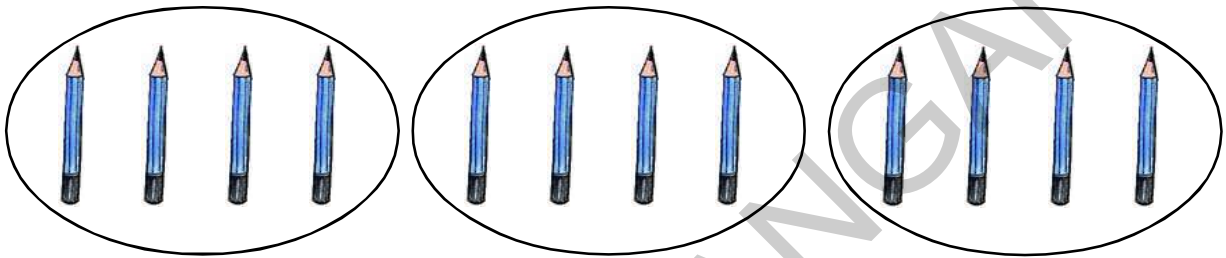

Sonu says that when 12 pencils are divided equally among 3 people each person will get 4 pencils.

Sonu's classmate- You are correct. 12 divided by 3 is equal to 4. This is written as

$$12 \div 3 = 4 \text{ and also as } \frac{12}{3} = 4$$

Do These

- Write the following statements as Sonu's classmate has done above.
 - Latha makes 6 wadas and divides them equally among her 3 children.
 - The teacher divides 16 notebooks equally among 8 children.
 - Mother divides 10 rotis equally among 5 family members.
- Express the following in the form of statements.

(a) $\frac{4}{2}$

(b) $\frac{14}{2}$

(c) $\frac{15}{3}$

(d) $\frac{16}{2}$

(e) $\frac{18}{6}$

Divide roti's equally



The teacher asked the children

How will you divide 1 roti equally among 2 people?



Children drew pictures of roti's in their notebook and showed the teacher.

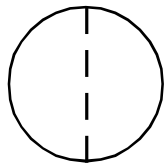

Kamala

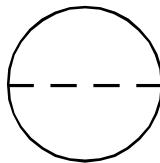

Rama

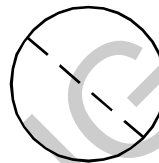

Krishna

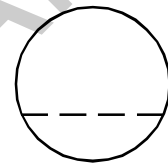

Suresh



You have to divide the roti into two equal parts. (Suresh! The two parts in your picture are not equal? Correct it.) Now all of you tell me, how much roti, will each person get?

Each person will get 'half' a roti.



Kamala

Teacher : Yes, half means one part out of two equal parts. This is written as $\frac{1}{2}$.

So,

$$1 \div 2 = \frac{1}{2}$$

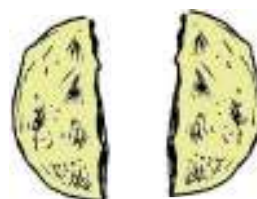

Teacher : Now, divide one roti equally among 4 people.

Kamala drew this picture in her notebook.

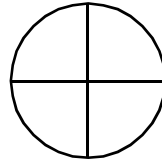

Kamala : Each one of them gets 'quarter' part of the roti from four equal parts.

Teacher : Correct, we write this as $\frac{1}{4}$

So, $1 \div 4 = \frac{1}{4}$



Teacher : Now, can you divide 3 rotis among 2 people.

Kamala did it like this-

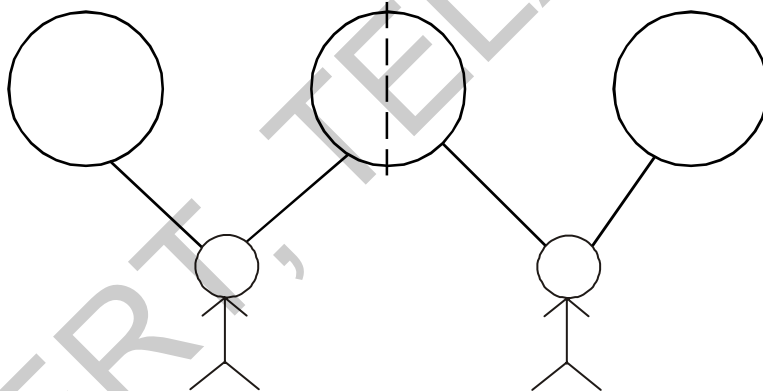

Kamala : When I divide 3 rotis among 2 people each person will get one full roti and one half roti.

I can write this as-

$$\frac{3}{2} = 1 + \frac{1}{2}$$

Now, you divide these 5 rotis equally among 2 people-

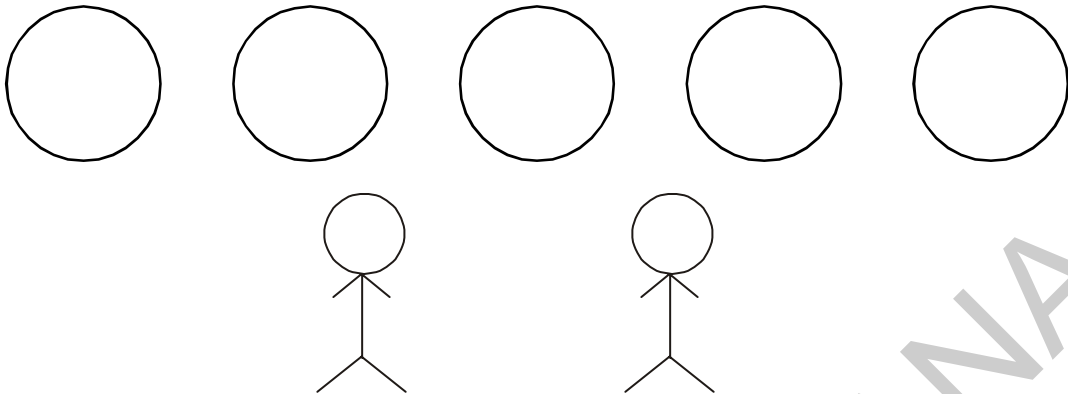

- (a) How many full rotis will each person get? _____
(b) How many half rotis will each person get? _____

So, $\frac{5}{2} = \underline{\hspace{2cm}} + \underline{\hspace{2cm}}$

Try to divide these 5 rotis among 4 people.

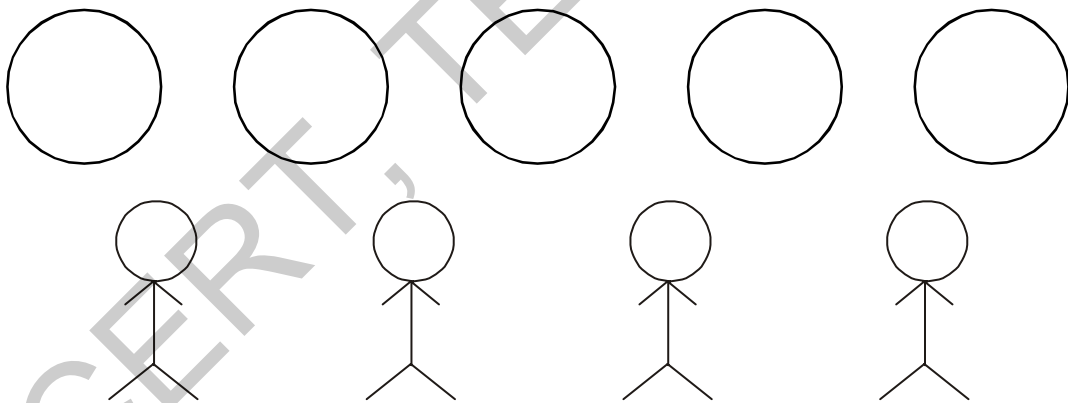

- (a) How many full rotis will each person get? _____
(b) How many one-fourth rotis will each person get? _____

So, $\frac{5}{4} = \underline{\hspace{2cm}} + \underline{\hspace{2cm}}$

Let us divide one watermelon into equal parts

Sonu likes watermelon. Her mother bought one from the market.

She cut it into two equal parts. She gave one part to Sonu and the other part to Koushik.



- (a) What part of the watermelon has Sonu got? _____
- (b) What part of the watermelon has Koushik got?

- (c) If there were 2 more people who had to be given watermelon equally, how many parts would the watermelon have to be divided into?

- (d) What part of the watermelon would each person get? _____



Now, divide this cake equally among four people.

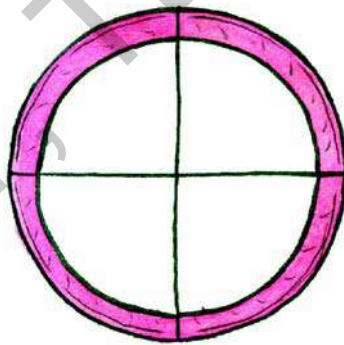

- (a) One cake divided into four equal parts is written as $1 \div 4$ and also as _____
- (b) On dividing the cake what part of the cake will each person get? _____
- (c) If a person eats 2 out of 4 parts of the cake, what part of the cake did she/he eat? _____
- (d) Shade this part on the cake. Is it equal to $\frac{1}{2}$ of the cake? or not? _____
- (e) If one person eats 3 out of 4 parts of the cake, what part of the cake did she/he eat?

Try This

1. Take a piece of paper. Divide it into half in as many ways as possible.
2. Take another piece of paper. Divide it into four equal parts in as many ways as possible.

Do These

1. The figures given below have been divided into equal parts. What part of each figure is shaded? An example is given below.

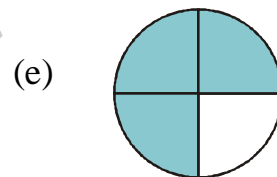
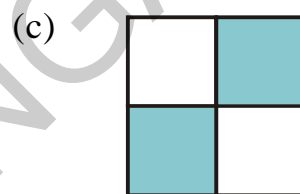
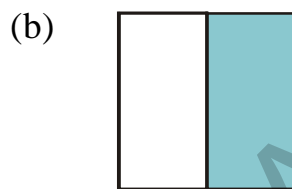
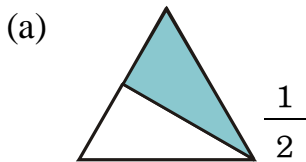

2. Colour that part of the figure that has been written below it. An example is given below.

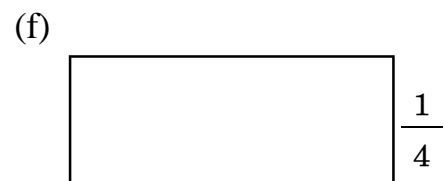
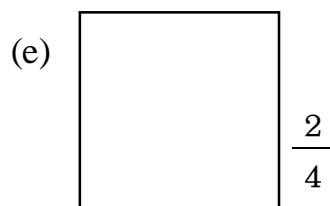
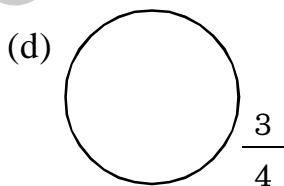
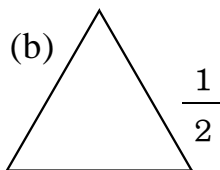

3. Colour $\frac{1}{2}$ of the group of figures given below.

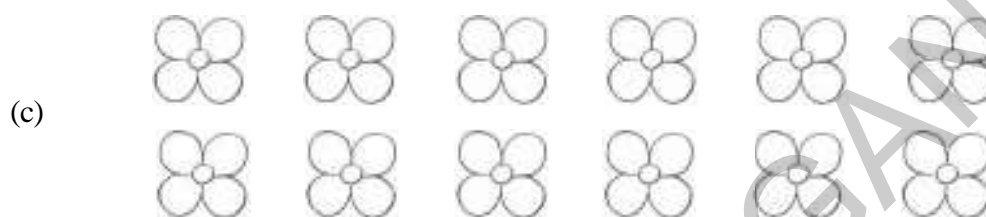

4. Colour $\frac{1}{4}$ (quarter) of the group of figures given below.

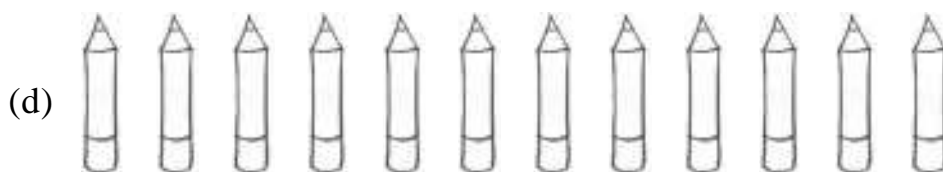
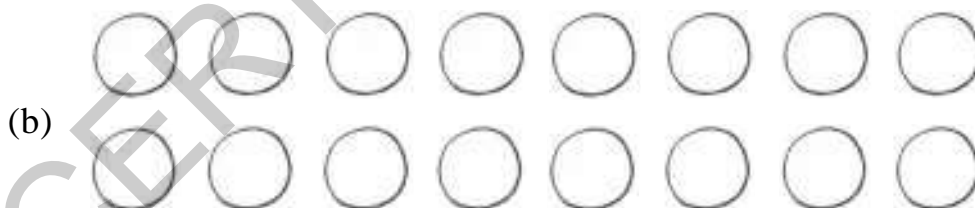

Try This

1. Think of more ways in which a rectangle can be divided into two equal parts and do them.
2. Think of more ways in which a rectangle can be divided into four equal parts and do them.

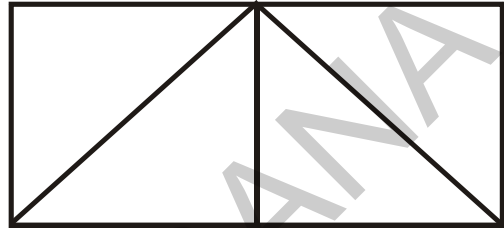
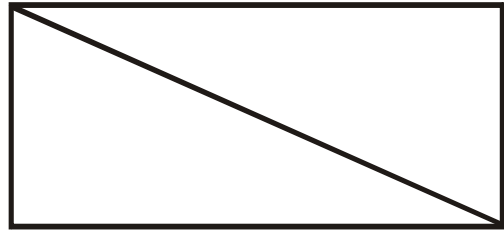

Rani's birthday

Rani bought 40 chocolates on her birthday.

- (a) She distributed $\frac{1}{2}$ of the chocolates in her class. How many chocolates did Rani distribute in class? _____
- (b) She distributed $\frac{1}{4}$ of the chocolates to her teachers. How many chocolates did Rani distribute among her teachers? _____

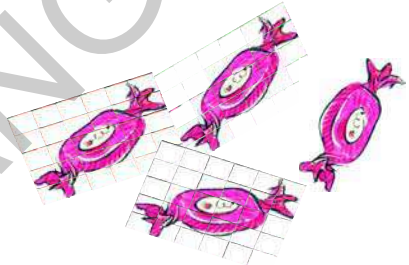

What part of the cupboard is filled with books?

- (a) What part of the shelves is full of books? _____
- (b) What part of the shelves is empty? _____



What part of the biscuit packet has been eaten?

- (a) If Saraswati and Komal have eaten 8 of the biscuits, what part of the biscuit packet have they eaten?

- (b) What part of the biscuit packet is remaining?

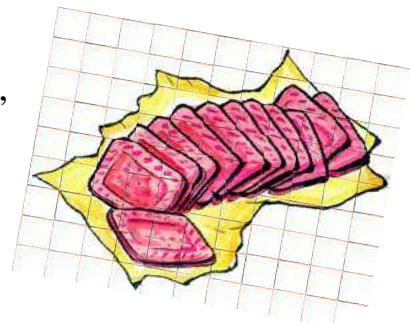

Exercise



1. Bhavani bought a dozen eggs. She used $\frac{1}{2}$ of the eggs to prepare omlets. How many eggs did she use? (1 dozen = 12)
2. Leela had 12 bananas. She ate one-fourth of them. What is the number of bananas she ate?



3. Shiva had 8 hens. He sold $\frac{3}{4}$ of the hens. How many did he sell?



4. Abhishek earned ₹ 100 in a day. He spent $\frac{1}{2}$ of the money on food. How much money did he spend?
5. There are 20 pages in a chapter. Usha has read $\frac{1}{5}$ pages of the chapter. How many pages has Usha read?

Try This



1. What part of your classroom blackboard is empty right now?
2. What is the total number of children in your class? What part of your class is boys? What part of your class is girls?
3. What part of the children in your class are present today?
4. What part of the teachers in your school are present today?
5. Make 5 more problems as given above.



Jyothi teacher has written the grades of her Class 4 students in the register as follows.

Akhila	A	Sonia	C	Uday	B	Sarala	A
Raju	A	Gopi	B	Anil	A	Urmila	B
Amzad	C	Leela	B	Deepthi	B	Ramesh	B
Vinay	B	Shameen	A	Sruthi	C	Srinu	A
Hampi	A	Pragna	C	Roja	B	Prasad	B
Rani	B	Fahim	A	Mangala	A	Kamala	B
Krishna	A	Komal	B	Kalpana	B	John	C

The Headteacher of her school asked her to report the number of students who have got A, B and C grades. To find this out, Jyothi teacher makes a table and puts a tally mark for each grade she comes across as she goes down the list. She has made marks for Akhila, Raju, Amzad and Vinay according to their grade. Can you help the teacher in completing the table.

Grade	Tally marks	Number of students
A		
B		
C		

1. How many children got A grade?
2. How many children got B grade?
3. How many children got C grade?

Which is your favourite game?

Make a list of all the children in your class. Ask each child their favourite game and record this against their name, for example, Sudhakar- skipping. Using this information, complete the table given below-

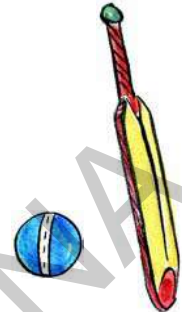
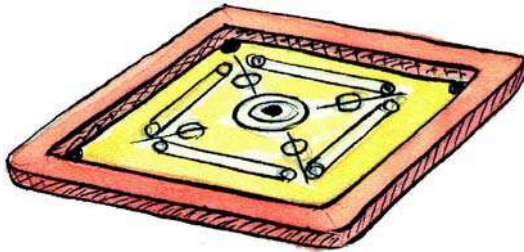

Name of game	Tally marks	Total

1. Which is the most popular game among children of your class?

2. Which is the least popular game among children of your class?

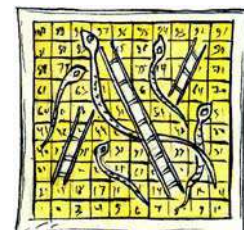

How big are the families that live around you?

Visit 20 houses in your locality. Find out how many people live in each house. Use this information and complete the table given below.

Family size	Tally marks	Number of families
7 members and above		
6 members		
5 members		
4 members		
3 members		
2 members		
1 member		

What conclusions can you draw from this data?

Types of houses :

In a small village Yellapur, there are 3 types of houses. The information has been given below. With the help of tally marks fill this tables.

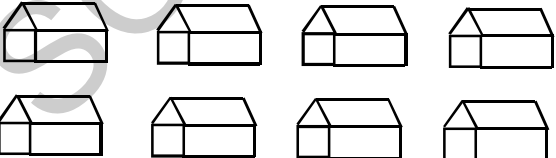
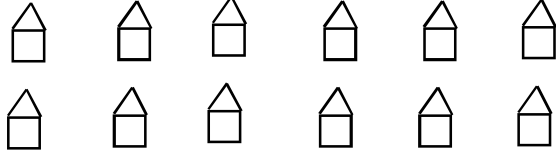
Type of house	tally marks	No.of houses
		
		
		

Picture Tables and Charts

Abdullah's Toy Shop

Abdullah has a small toy shop. He has 10 toys of each type in the beginning of May. The picture table given below provides information about the stock of toys at the end of the month.









1. Which toy is the most in stock at the end of the month?
2. Which toy is the least in stock at the end of the month?
3. Which toy has been sold the most in the month?
4. Based on the table above, say which type of toys children like the most?

Helping Hands!

Class 4 students of Palampet Primary School decided a target of collecting ₹ 300 in a week for an orphanage home. They asked ₹ 5 donation from each person they approached.

The picture table given below provides a description of how much money they collected on each day of the week.

Day	Money collected	Total money
SUN		
MON		
TUE		
WED		
THU		
FRI		
SAT		

1. On which day was the collection highest?
2. On which days did they collect the same amount of money?
3. Did the class meet its target?

Bags of paddy

Mallaiah is a farmer. He has been keeping a record of the production of paddy for four years. Each bag is equal to 50 kg of paddy produced.

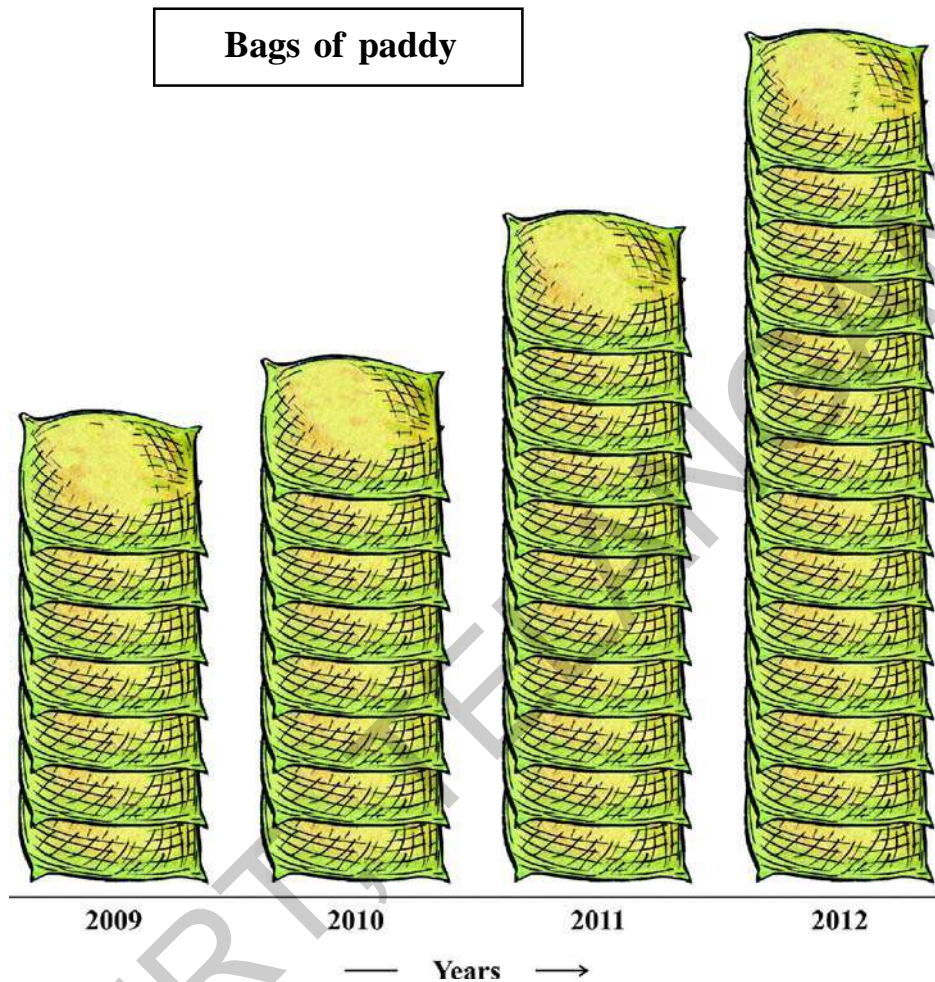

1. In which year the production of paddy is highest? How much?

2. In which year did the paddy production was double to that of 2009?

3. Mallaiah's paddy production has steadily increased over the past four years. Can we draw this conclusion from the above picture chart?

Box Charts

How much oil is in stock?

An oil merchant sells groundnut, palmolein, sunflower, coconut and rice bran oil. The box chart given below provides a record of the stock of oil packets at the end of the week.

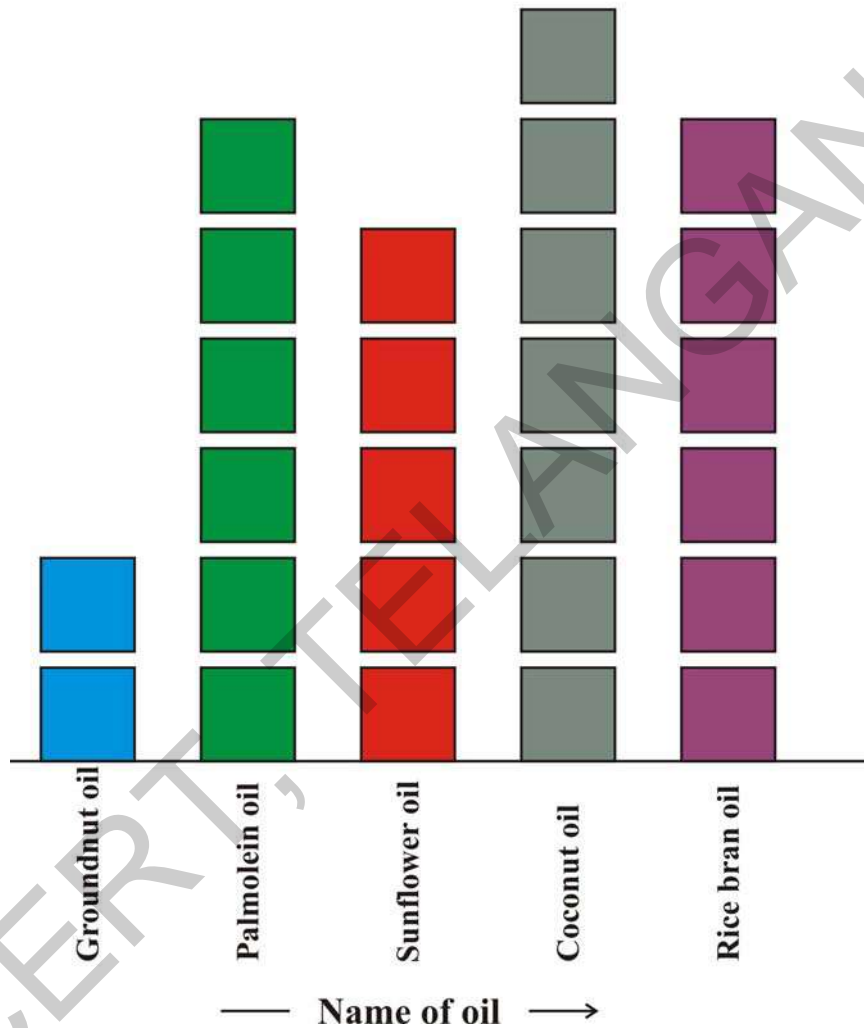

1. Which oil is lying most in stock? _____
2. Which oil is lying least in stock? _____
3. If there were 30 packets of groundnut oil in the beginning of the week then how many have been sold in the week? _____
4. If there were 20 packets of sunflower oil in the beginning of the week then how many have been sold in the week? _____

14

Borders and boundaries

The students of Venkatapur Primary School wanted to decorate their classrooms on Republic Day. They decided to decorate the blackboards by sticking streamers all around their edges.

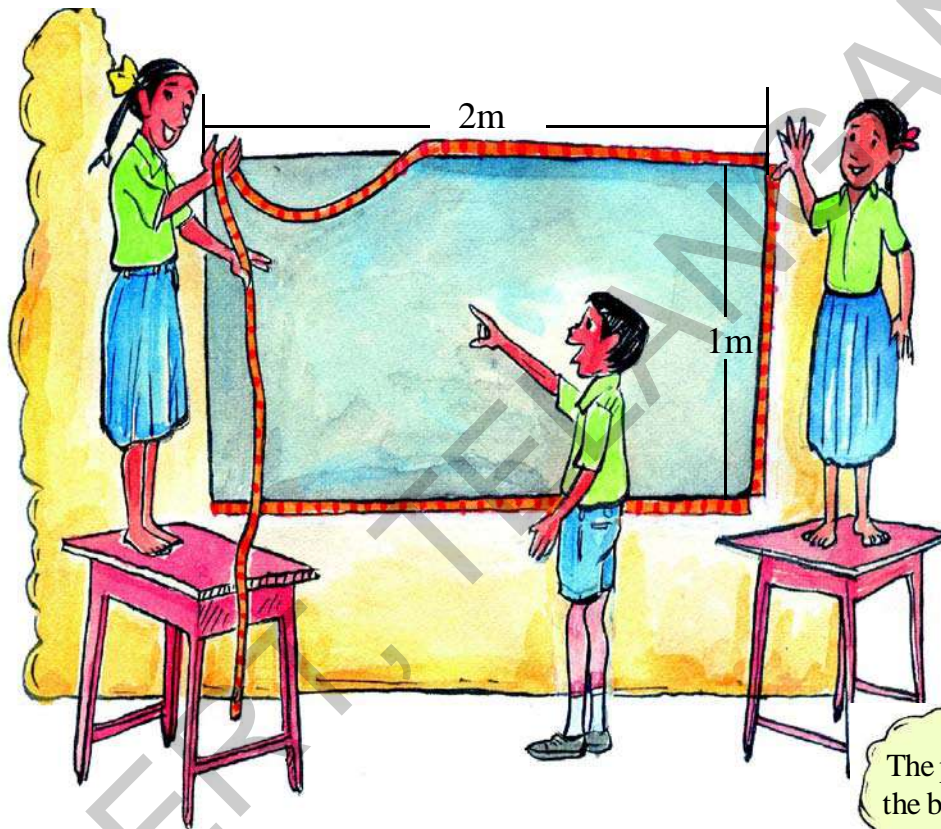

The perimeter of the blackboard is 6 meters

How much of streamer paper should they buy for one blackboard?

The students measured the sides of blackboard Then they added the lengths of all the four sides-

$$2\text{ m} + 2\text{ m} + 1\text{ m} + 1\text{ m} = 6\text{ m}$$

Thus, they recognised that the total length of streamer paper required is 6 m.

Are they correct? _____



Fencing the fields

Ramaiah, Ahmed and John are friends. They have decided to fence their fields.

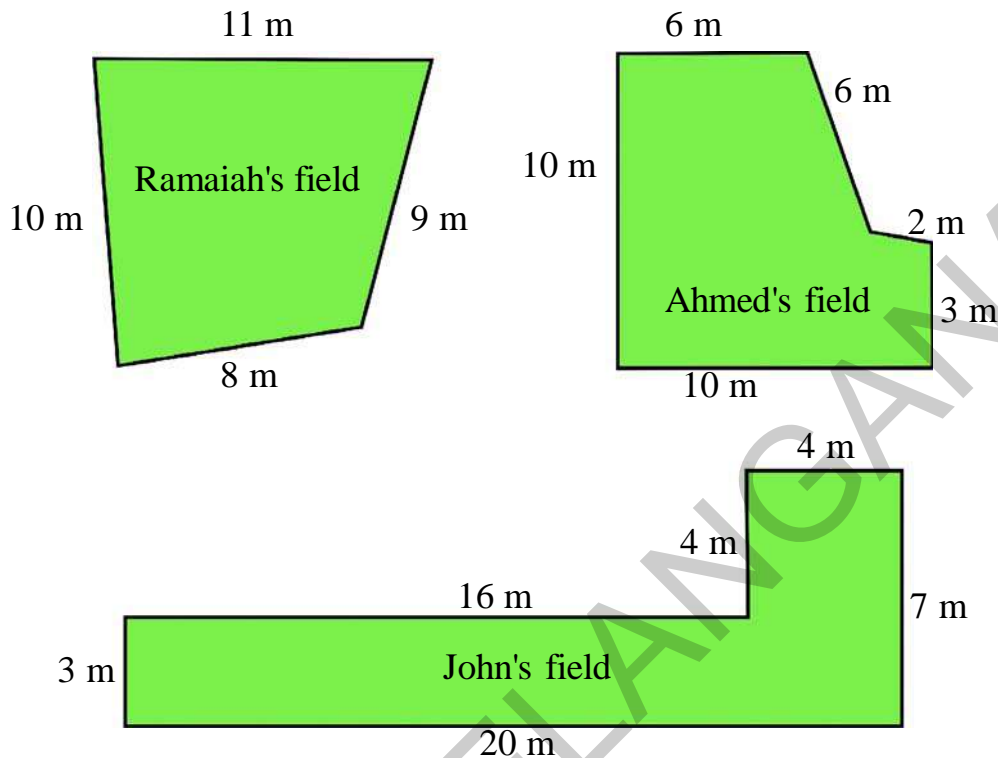

They went together and bought 100 meters of fencing wire. Will this be enough to fence all their fields?

Do These

1. Observe the field spaces given below. Find their perimeters.

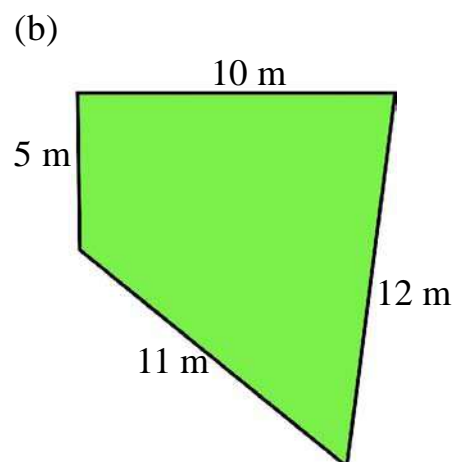
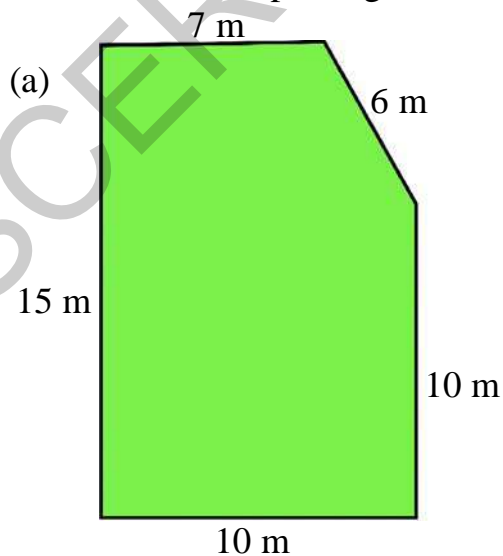

Try This

1. Estimate the perimeter of your classroom. Then measure it with a measuring tape.

Borders and Laces

- (a) Salma thought to go to the lace shop to buy lace for her dupatta. How much lace does she need? _____ 2 m 50 cm

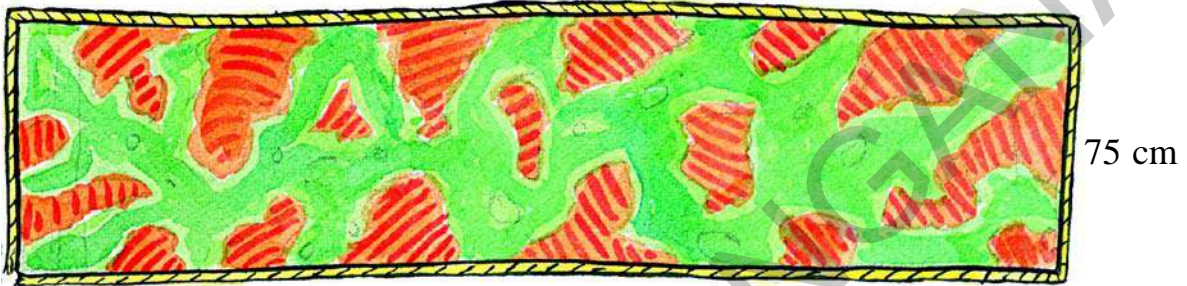

- (b) If one meter of lace costs ₹ 12, then how much money should Salma pay to the shopkeeper? _____

Vasudha wants to put a special lace all around the border of her new sari. The length of the sari is 5m 50cm and its breadth is 1m 50cm.

- (a) What is the length of lace that Vasudha needs _____

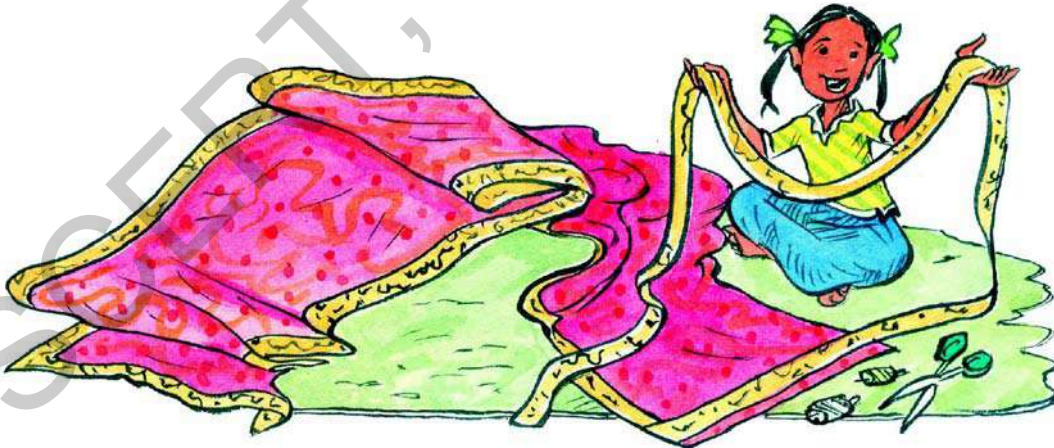

- (b) If 1m lace costs ₹ 75, then how much does Vasudha has to pay to the shopkeeper? _____

Try This

1. (a) What is the perimeter of the square given in the picture? _____

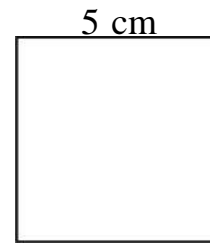

- (b) If I remove a square of length 1cm from one corner, of a square will the perimeter of the square change? _____

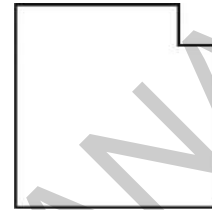

- (c) What happens when I remove from all four corners? _____

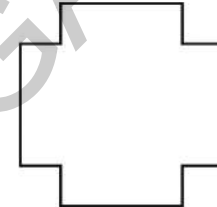

- (d) Look at the figure. What would be its perimeter? _____

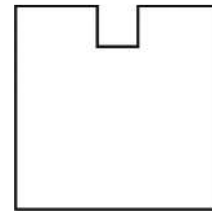

2. (a) How can we measure the perimeter of this field?



- (b) Uma and Shreya are racing each other on a circular track. Uma is running on the inner track and Shreya is running on the outer track. Both are starting their run from different positions. Can you guess, why?

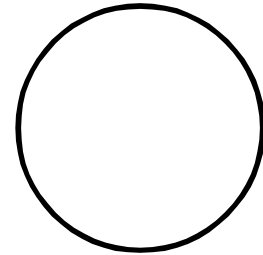

Exercise

1. Find the perimeter of the enclosures given below-

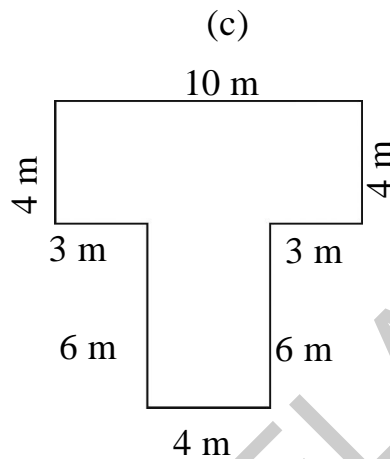
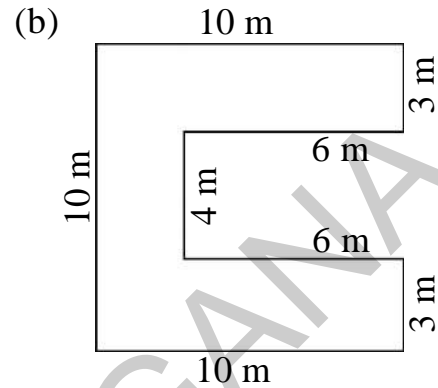
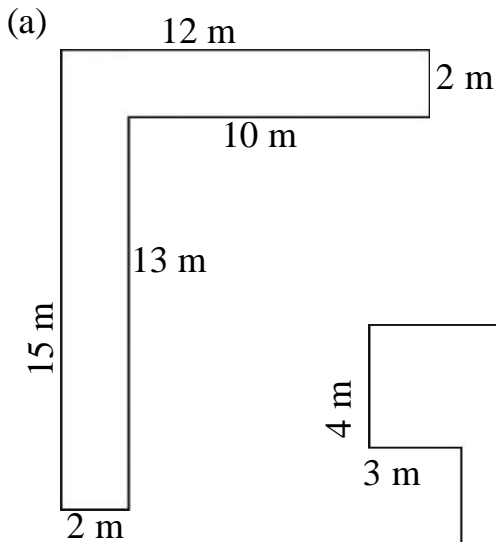

2. The measurements of Ranga's and Rama's fields are given below. They both want to buy fencing wire. Who needs more wire?

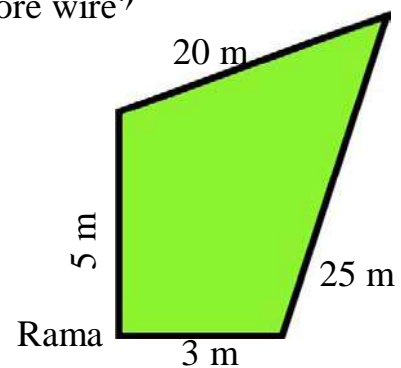
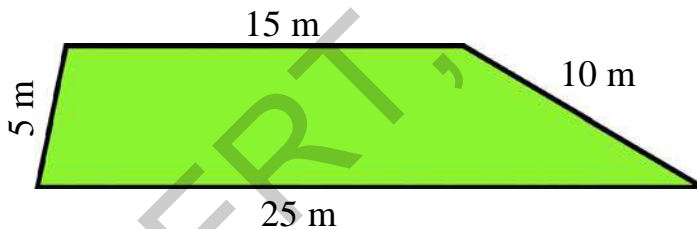

3. Ravi takes 3 rounds of this garden, everyday in the morning. What is the total distance he walks each day?

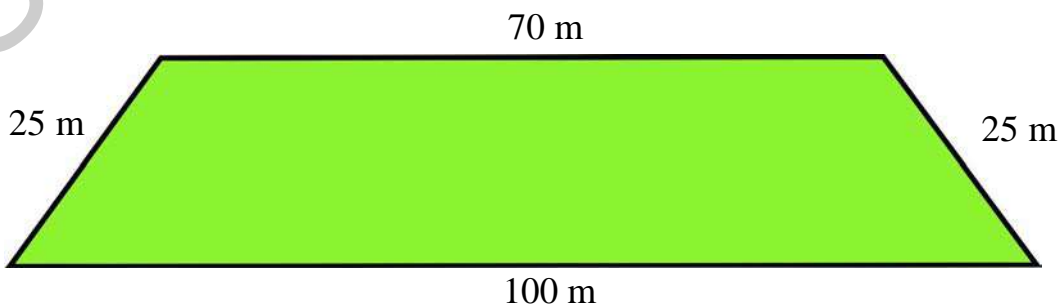



Bhavya was making a rangoli outside their house.

Her mother told her- "Bhavya! stop the rangoli. Go to shop and get me some haldi. Your sister will complete the rangoli".

Bhavya's sister Navya completed the other half of the rangoli.



Are there any other ways in which you can divide this rangoli into halves that look alike as shown in the figure above?

Navya told Bhavya "I will draw half of the rangoli. You complete it."

Help Navya in completing the rangoli.

Put a mirror along the incomplete part. What do you find?

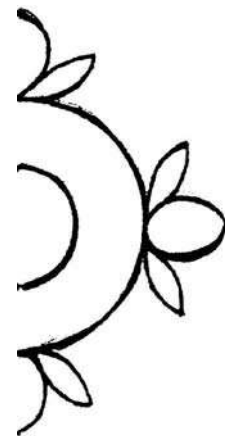



Do These

1. Draw a line to divide the following pictures into halves that look alike. Not just as shown in the first picture, there may be more than one way of doing this.

Ex:

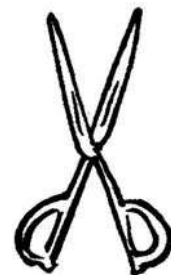
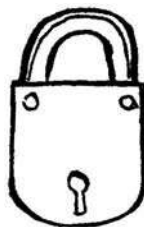
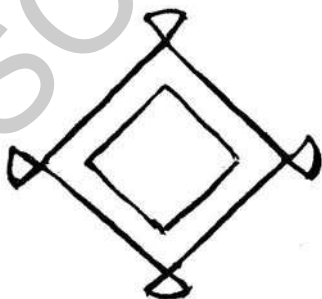
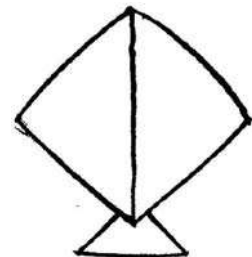
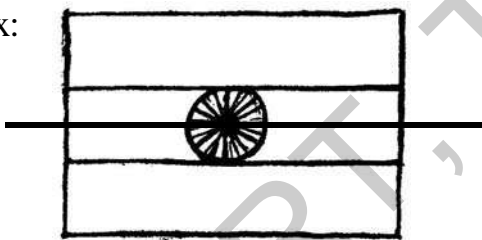

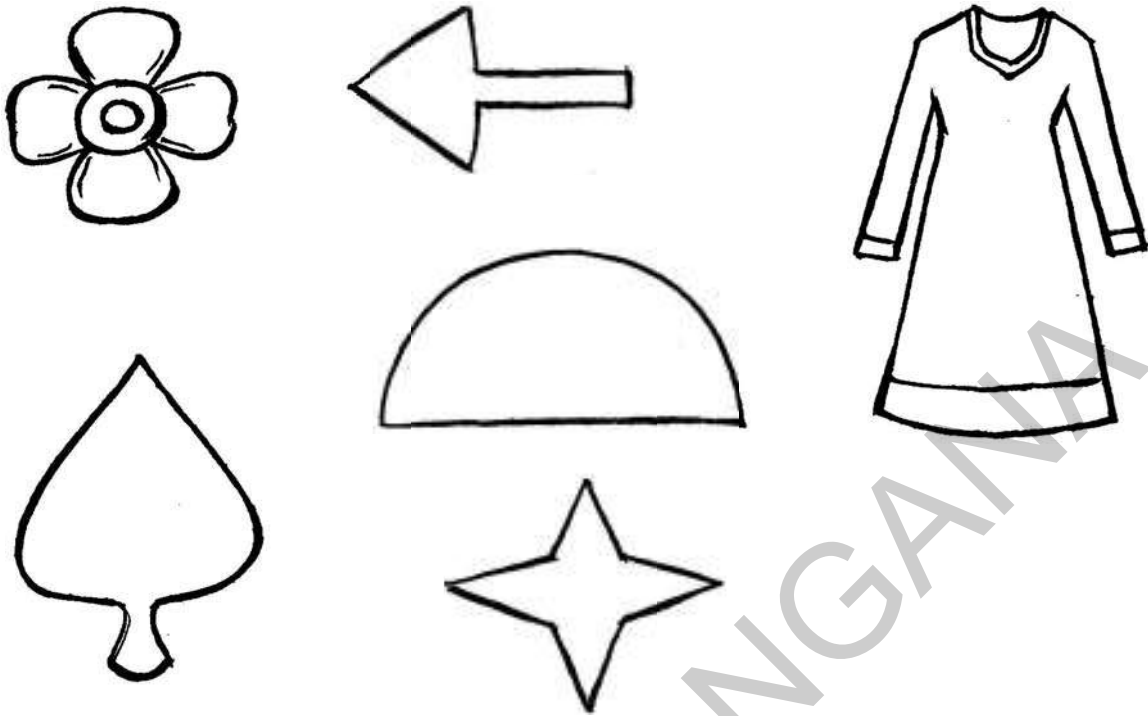

2. Draw a line which divides the figures given below into halves that look alike.
 Note: You can find more than one way in which each figure can be divided.

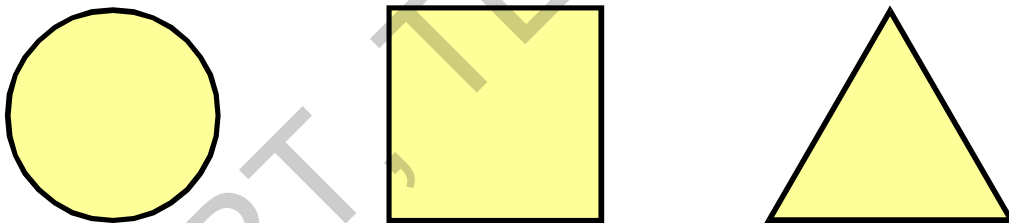

3. Can numbers be divided into halves that look alike as you have done above?
 Which of the following numbers can be divided into halves that look alike? As you have done above, draw the line which divides the number into halves. An example has been given.

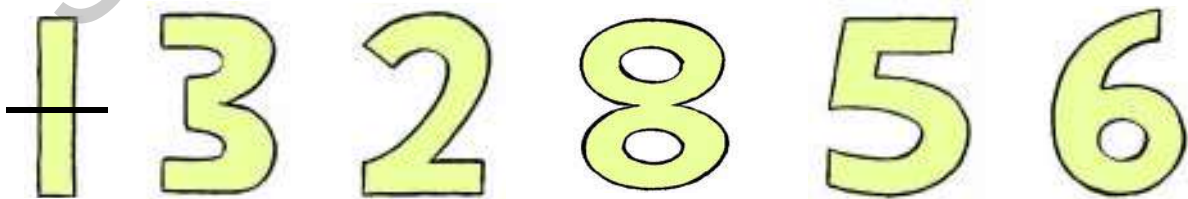

Try This

1. Observe the things around you. State which are the objects that can be divided into halves that look alike.

Activity



Let's make a mask

Let us make a mask of an elephant's face.

1. Take a paper. Draw a line which divides it into half.
2. Draw half face of an elephant on one side of the paper as shown below.
3. Now fold the paper along the line.
4. Cut along the outline of the face of elephant using a scissors.
5. Open the fold and draw eyes.
6. Colour it and tie a rubber band to it so that it can be used like a mask.

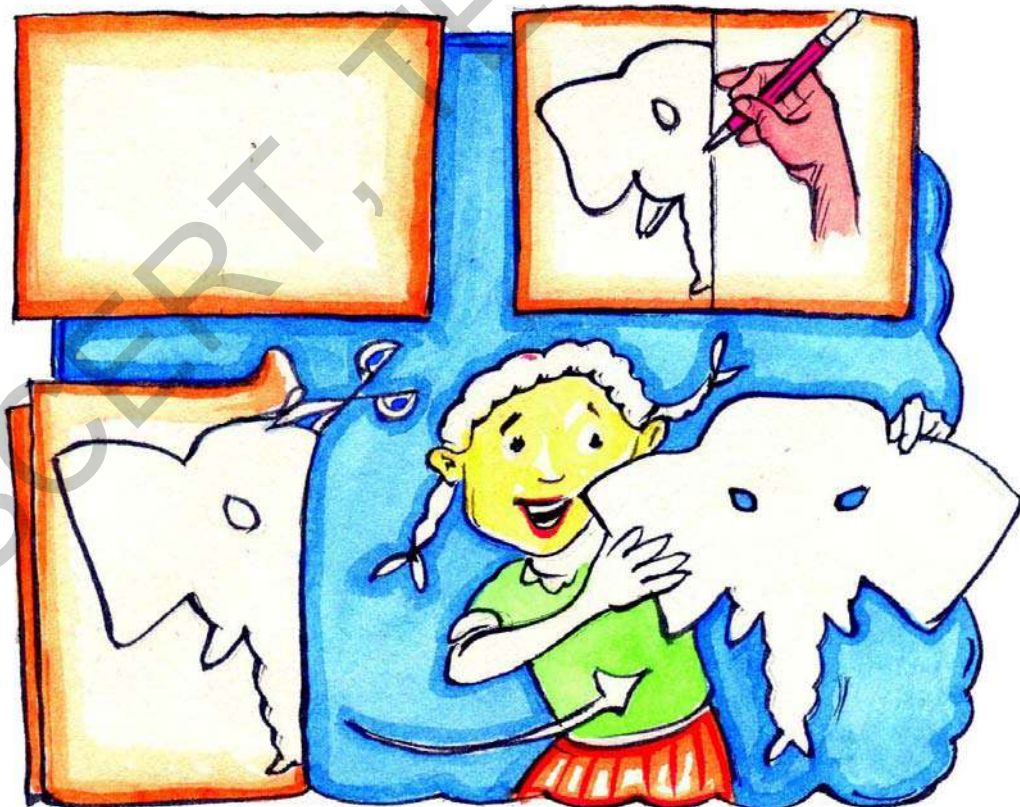



Rajitha and Sravanthi are going to a Jathara. On the way they crossed various houses.

Rajitha: Sravanthi! look at the beautiful patterns on the boundary walls of these houses.

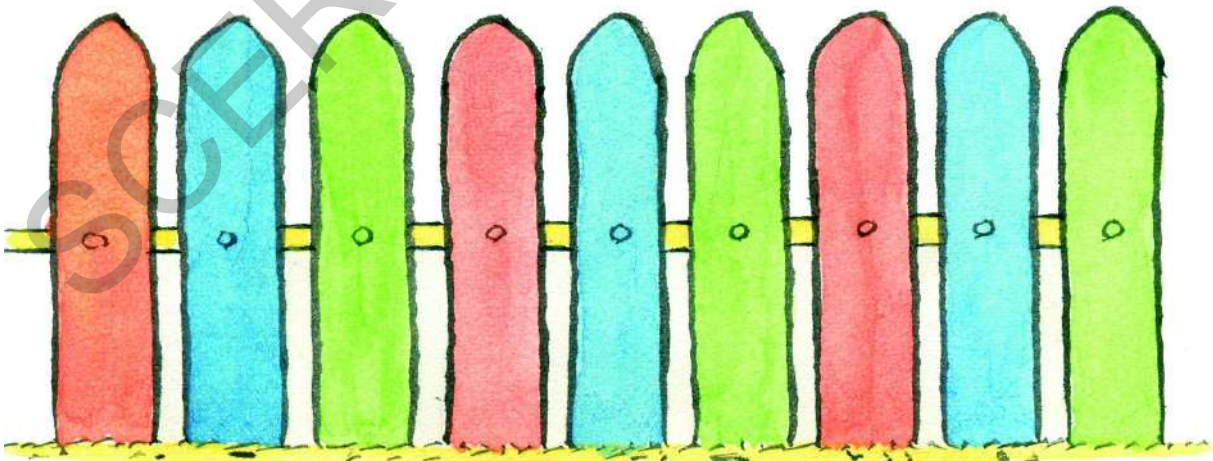

Identify the part of the boundary wall is repeating itself to make the pattern.

Sravanthi: Look, there are patterns on the grills of the boundary walls of this house.



Identify which part of the grill is repeating itself to make the pattern.



At the bus stop they were standing under a tree, waiting for the bus.

Rajitha: Look here Sravanthi! The leaves of this stalk are also in a pattern.

While travelling in the bus, Rajitha and Sravanthi went over this bridge.

Did you notice any pattern in the construction of the bridge?

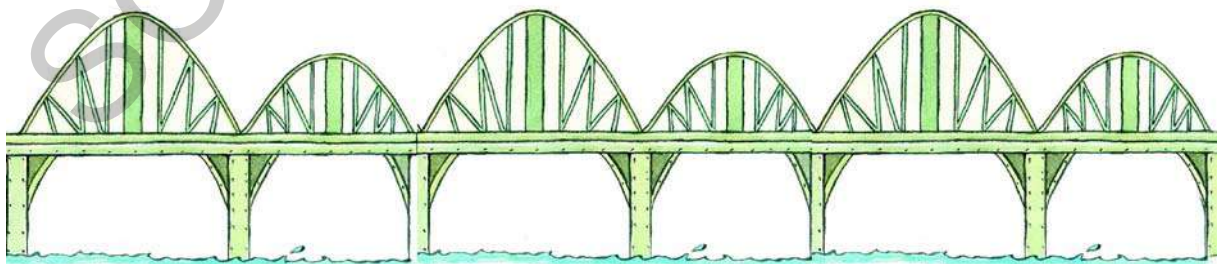

Think ! What are the things around you that you see patterns in?

At the jathara, Sravanthi and Rajitha purchased pearl chains for themselves.



1. Recognise the pattern in the pearl chains given below and extend the chain according to the pattern.

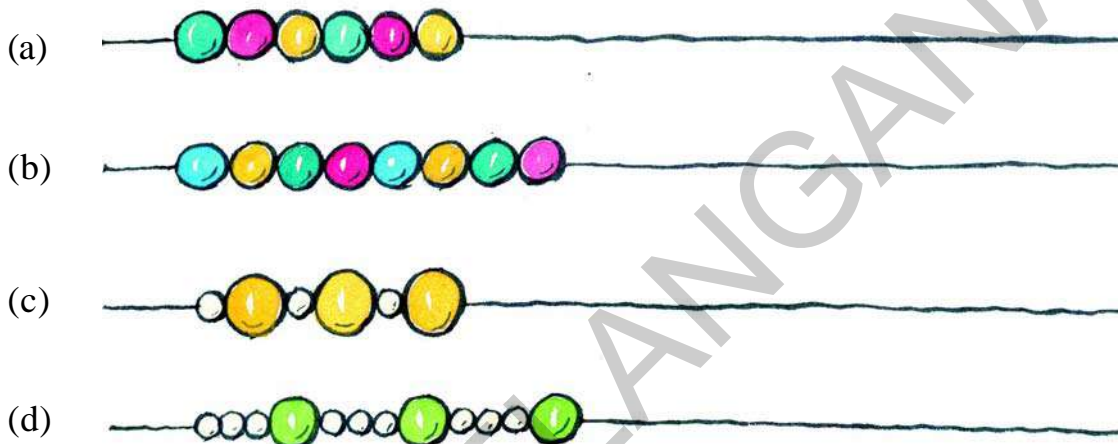

2. Here are some other chains that the girls saw at the jathara. Identify the pattern and add two more beads to them-

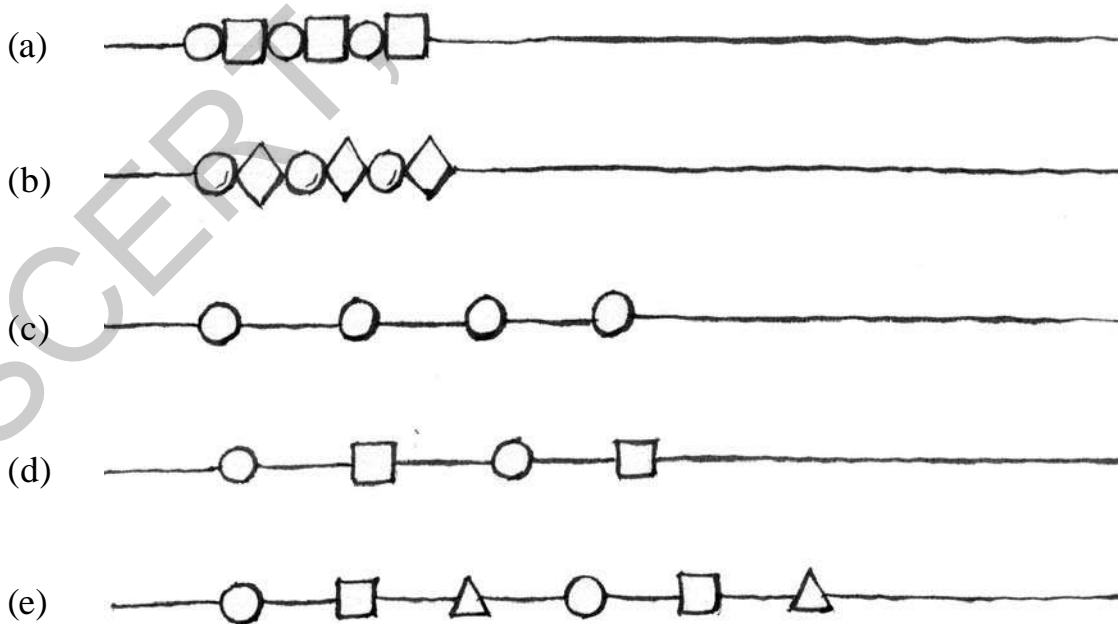

Do These

1. Draw three chains of different patterns.

Patterns with turns

These children are playing in the playground during mid-day meal time.

Did you notice a pattern in the way they are standing?



These children are playing kho-kho. Is there any pattern in the way they are sitting?



Yes there is a pattern. Every alternate child is facing the opposite direction.

Do These



1. Carry forward these patterns.

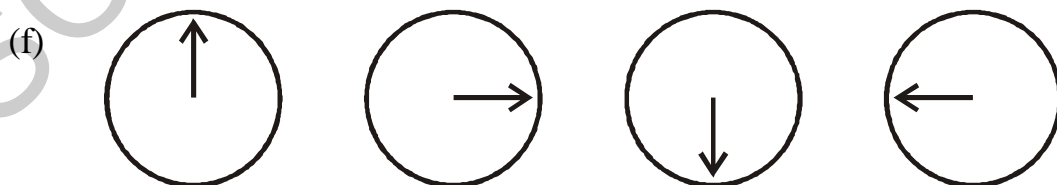
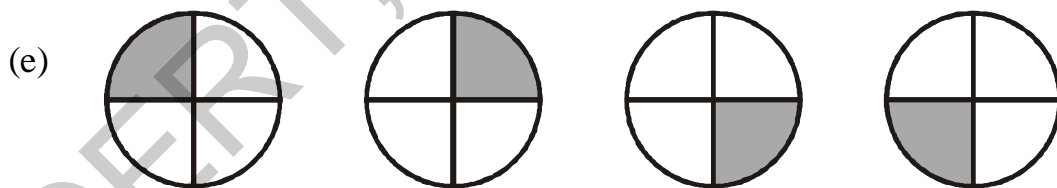
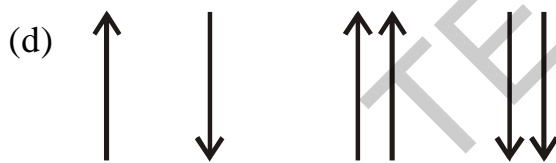
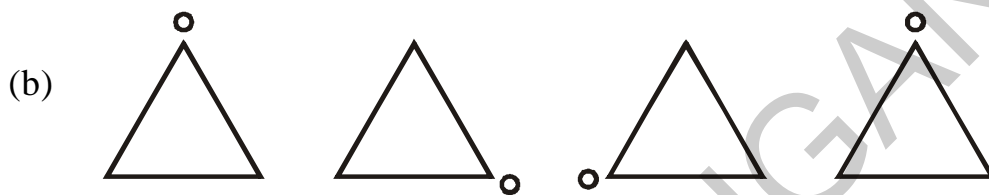
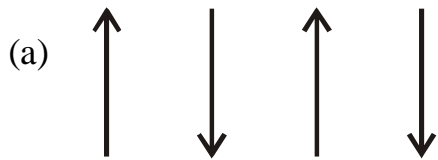

Patterns in numbers

Identify the patterns in the series of numbers given below.

1. Write the next three numbers in these series of numbers.

(a) 2, 4, 6, 8, _____

(b) 1, 3, 5, 7, _____

(c) 3, 6, 9, 12, _____

(d) 11, 15, 19, 23, _____

(e) 15, 13, 11, 9, _____

(f) 21, 27, 33, 39, _____

(g) 40, 35, 30, 25, _____

(h) 3, 6, 10, 15, _____

(i) 8, 16, 24, 32, _____

(j) 49, 42, 35, 28, _____

(k) 70, 60, 50, 40, _____

(l) 9, 19, 29, 39, _____

(m) 36, 45, 54, 63, _____

What is the relationship between the consecutive numbers in the series?

Some of these patterns are increasing.

Some of these patterns are decreasing.

2. Now, identify the patterns in the number series given below and carry it forward.

- 1) 3, 6, 12, 24 _____
- 2) 4, 8, 16, 32 _____
- 3) 32, 16, 8, 4 _____
- 4) 2, 6, 18, 54 _____
- 5) 5, 20, 80 _____
- 6) 800, 400, 200 _____

Patterns in the calendar

Choose any 9 numbers as shown in the calendar.

What is their sum?

Vani added the numbers as follows.

$$13 + 20 + 27 + 14 + 21 + 28 + 15 + 22 + 29 = 189$$

May-2013

S	M	T	W	Th	F	Sa
			1	2	3	4
5	6	7	8	9	10	11
12	13	14	15	16	17	18
19	20	21	22	23	24	25
26	27	28	29	30	31	

Rama- I can do it faster. I will just multiply the middle number by 9 and get the answer- $9 \times 21 = 189$

Choose any 5 numbers as shown in this calendar.

What is their sum?

Vani added all the numbers- $2 + 9 + 16 + 23 + 30 = 80$

Rama said- I can also do this quickly by multiplying the middle number by 5.

Is Rama correct?

May-2013

S	M	T	W	Th	F	Sa
			1	2	3	4
5	6	7	8	9	10	11
12	13	14	15	16	17	18
19	20	21	22	23	24	25
26	27	28	29	30	31	

Do These

1. Take any other 9 numbers as shown above. Find out if this pattern is true for those 9 numbers too. You can use any month of any calendar.
2. Take any other 5 numbers in the calendar. Find out if the pattern is true for those 5 numbers. You can use any month of any calendar.



Santosh's sister is going to be married in a week. Everybody in the house is busy with the preparations.

Today Santosh, his sister Anitha and their parents are going to the market, to shop for clothes. Anitha and her mother entered their favourite saree shop. They looked at many sarees and finally selected these-



₹ 1500



₹ 2000



₹ 3200



₹ 850



₹ 1300

Notice the different patterns on each saree. Also notice the patterns on your mother's sarees.

1. What is the total amount they spend on the sarees? _____
2. If they give ₹ 9000 to the shopkeeper, how much money will the shopkeeper return? _____

Meanwhile Santosh and his father went and looked at the men's clothes. They both bought cloth for their shirts and pants.



3. Given below is the bill that the shopkeeper prepared. Complete it-

Item	Rate per meter	Amount
1 m 50 cm pant cloth	₹ 150	
1 m 50 cm pant cloth	₹ 220	
2 m shirt cloth	₹ 140	
2 m shirt cloth	₹ 125	
Total		

Buying sweets for the marriage

They then went to the sweet shop. They placed an order for 20 kg of laddus and 20 kg of badusha. 1 kg of laddus costs ₹ 120 and 1 kg of badusha costs ₹ 150.

1. How much will they pay to the sweet seller?
2. Santosh asked the shopkeeper to pack the laddus in boxes of half kg. How many boxes of laddus will the shopkeeper give them?

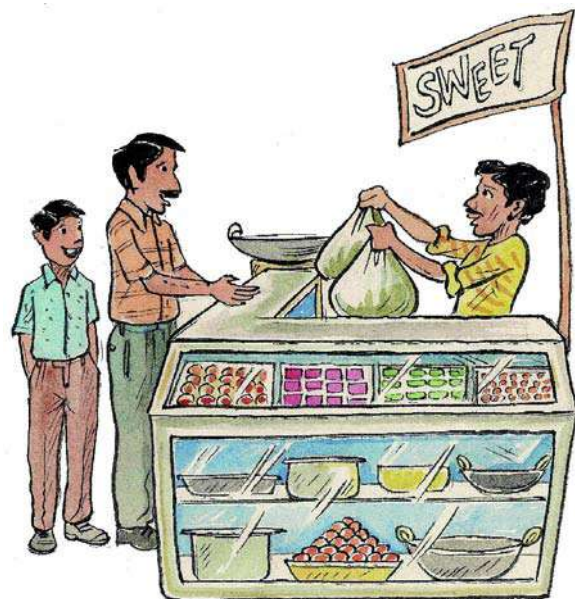

Posting wedding cards

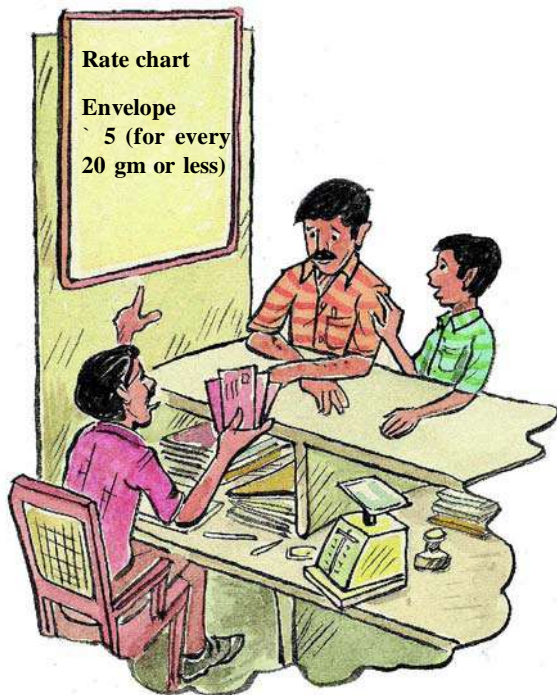

Santosh then went to the post office to post the wedding cards to friends and relatives. The post master weighs the marriage card and tells Santosh that it weighs 35 grams.

1. How much does Santosh have to pay to the post master for posting 200 cards?

The family members came back very happily after completing their shopping and the works they have planned for that day.

Preparation for the journey

The marriage is going to take place in Warangal at the bride groom's house. Many members of the family will be travelling for the marriage, so Santhosh's father decides to hire buses to travel. The next day Santosh and his father went to the bus agency.

His father estimates that about 4 people from each of 40 families will travel for the marriage.

1. About how many people will travel for the marriage?

The bus agency told him that each bus contains 15 rows of seats and 4 people can sit comfortably in each row.

1. How many people can be seated in each bus?
2. How many such buses will be required?
3. Will there be empty seats in any bus if the number of people who travel for the marriage are as per father's estimation? How many?

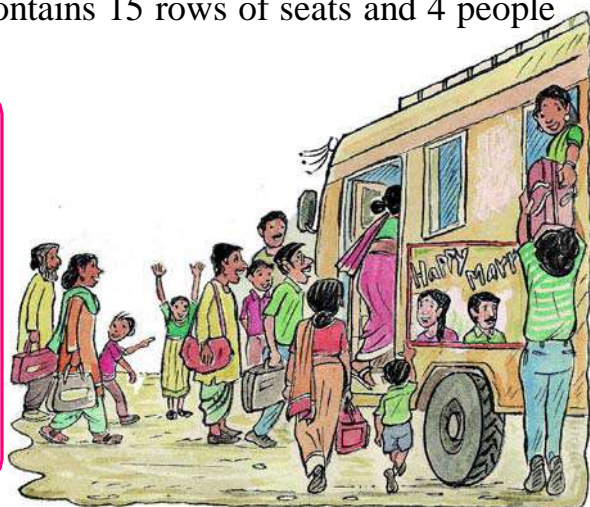

Father agrees to pay the bus agency ` 12 for every kilometre travelled.

1. If the distance from Adilabad to Warangal and back is 500 km then how much will father pay for one bus? How much will he pay for all the buses he has hired?
2. If father has given an advance of ` 4500 to the bus agency, how much does he need to pay after returning home?

Marriage party leaves for Warangal

On the day of marriage, the whole party started from Adilabad at 7 o' clock in the morning.

Tanu : When will we reach Warangal?

Aunty: If we don't stop anywhere, we will reach there in 5 hours.

Tanu : It is 7 o'clock now, so we will reach by _____

Manjeet: It is going to take 5 hours so it must be far.

Aunty : It is about 250 km.

Tanu : Are we going to stop anywhere?

Anand : May be at Karimnagar, about 180 km from here.

1. At about what time will the buses reach Karimnagar?
 - (a) Before 10 o'clock
 - (b) Between 10 and 11 o'clock
 - (c) After 11 o'clock

Soon the children and young people started playing antyakshari and the bus was filled with melodious songs. Meanwhile the elders were enjoying the view of the beautiful forests and hills.

They crossed the Rayapatnam bridge on the beautiful river Godavari at the Adilabad border and children started excitedly looking outside the windows

Anu : Wow! Look how beautiful Godavari is. It is soooo.. big!



Purchasing flowers

While everybody was having tea, Santosh went to buy flowers to greet the groom's family. He bought 35 cubits of jasmine flower garlands.

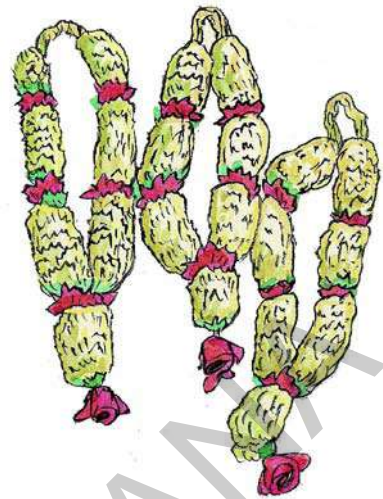

1. About how many cubits of jasmine will make a garland? _____
2. They reached Warangal safely at 1 : 30 in the afternoon. How much time did they take to reach Warangal? _____

The marriage at Warangal was a very happy occasion for both the families.

Try This



1. What are the types of mathematical calculations that need to be made during marriages in your house?
2. What are the types of mathematical calculations that need to be made when your family go out for a holiday?

GUIDELINES FOR TEACHER

Curricular and Pedagogical

Dear teachers,

There are 17 chapters in this book. Broadly, they cover two areas- numbers and space. Building number sense at the primary stage involves an ability to read, write and understand bigger numbers as well as skill in the four fundamental operations- addition, subtraction, multiplication and division. It also involves seeing relationships between different operations for e.g., between addition and subtraction and between multiplication and division as well as engaging with properties of operations like commutative and distributive properties. Ability to engage with number patterns is also an integral part of a growing number sense. Fractions build up on the understanding of division and also prepare children for denser concepts such as percentages, ratios etc., as well as a growing number set, all these to come in the upper primary classes. Spatial understanding is about seeing the world in terms of 3D and 2D shapes, understanding the relationship between the 3D and 2D world, visualizing the world from different positions and also exploring patterns and symmetry. Measurements involve quantification of various spatial and non spatial concepts like length, weight, capacity, time and perimeter and the use of the four operations in all of these areas also consolidates number sense. Estimation remains an important part of both numbers and space. Data handling involves visualizing numbers through various types of pictures and graphs. We request you to help children enjoy both the numerical and spatial aspects of mathematics.

There are a few things that we would also like to mention about the nature of classroom transaction in a primary mathematics classroom. First, using concrete objects is essential at this stage. Some examples of concrete objects that are needed at the primary stage are dice, number cards, the 100 beads mala, meter rod, measuring tape, weights, clock, calendar, boxes of various shapes, bottles of various capacities, mirror etc. Second, concepts need to be placed in experiences that are meaningful for children such that children can see a connection between the mathematics they are doing in the classroom and the mathematics in the outside the world. The book makes an attempt to place concepts in situations that children can make sense of and we request you to also prepare more problems which will help children in relating concepts to local situations. Also encourage children to make their own mathematical problems and solve them. Third, there may be many ways to solve a problem. Please, encourage children to develop their own strategies to solve problems and also give space to them to discuss their strategies with each other. In fact, collaborative learning is a resource for the classroom and children should be encouraged to solve problems in pairs and groups.

You are also requested to organize field trips, metric melas, math exhibitions, learning corners, quiz, math club activities etc., whenever possible in the course of the year.

Lastly, we request all of you to read all chapters carefully and plan accordingly before you enter the classroom. We also feel that it would greatly benefit classroom transaction if you would solve all the problems given in a chapter before teaching it. There is also the expectation that you would arrange for whatever teaching learning material (TLM) is required for building concepts, for e.g., a meter rope for length, one litre bottles for capacity etc.

A note about the books: Children have been provided space to solve problems not only at the end of the chapter but at various points during the course of the chapter. In fact, the process of concept building is a process in which the child is engaging in a dialogue with the text and space is provided to him/her to articulate what he/she has understood at regular intervals. 'Do This' exercises provide children practice on the concept taught and are supposed to be done by the students on their own. 'Try this' exercises have an element of challenge to them and invite children to think. 'Think and discuss' problems again have an element of challenge and are also meant to be worked on in pairs and groups. The 'Exercise' given at the end of the chapter covers various learning points in the chapter. Teaching learning strategies and the expected learning outcomes, have been developed class wise and subject-wise based on the syllabus and compiled in the form of a Hand book to guide the teachers and were supplied to all the schools. With the help of this Hand book the teachers are expected to conduct effective teaching learning processes and ensure that all the students attain the expected learning outcomes.

Some chapter-wise guidelines are given below-

Shapes:

- Encourage children to identify both 3D and 2D shapes in objects around them.
- Also encourage an exploration of actual objects of different 3D shapes so that children can understand their various features.
- Provide space to children to articulate their understanding of these features rather than provide them with definitions.
- Encourage children to open various kinds of boxes and observe their nets.
- Create situations, where the children observe objects and locations from different views and encourage them to draw what they see.
- Showing some local maps of the school, locality, village etc., and encourage children to locate places on them.

Numbers:

- Help children understand the base 10 number system using contexts like the 100 beads mala, the number line, the 100 number table etc.
- Provide ample opportunities to children to make numbers from digits and compare numbers.

Addition and subtraction:

- Encourage children to add and subtract bigger numbers as well as estimate sums and differences
- Create many more meaningful word problems of all three types- 'combine', 'compare' and 'change' structures and ask children to solve them. It is also important to give children opportunities to make word problems of addition, subtraction and also those which involve both operations.

Multiplication:

- Encourage children to multiply bigger numbers as well as estimate products.
- Create many more meaningful word problems of all types- equal groupings, rate product, array product and cartesian product (in class 5) and ask children to solve them. It is also important to give children opportunities to make word problems of multiplication.
- Children should be given ample opportunities to split numbers at 10, 100 etc using the distributive law and then multiply.
- Encourage children to see the relationship between multiplication and division as well as commutative and distributive properties of multiplication.

Division:

- Encourage children to divide bigger numbers as well as estimate quotients.
- Create many more meaningful word problems of all types- Grouping and Equal sharing. and ask children to solve them. It is also important to give children opportunities to make word problems on division as well.

Fractions:

- Students use half, quarter, three fourth in their daily life without understanding them as fractional numbers. Use these meaningful experiences to introduce fractions to children.
- In understanding fractions it is important for children to understand that the whole can be one object or a group of objects. It is also important for them to understand that the object or group of objects is being divided into equal parts.
- It is also important to see the relationship fractions have with division and their entity as numbers on the number line.

Measurements:

- Length, weight, time and capacity have been used to introduce children to the area of measurements.
- Children have a variety of rich experiences in all these areas and they should be utilized in

classroom transactions. In fact, children whose parents are involved in professions that constantly engage with various units of length, weight and capacity should be treated as an invaluable resource for the classroom.

- A very important part of understanding length, weight, capacity and time is understanding how long a centimeter, meter etc is, how heavy a kilogram, few grams is, how much a litre is etc. So provide children opportunities to use a meter length rope, kilogram sack of sand etc and also the actual measures wherever possible.
- Wherever possible use field trips and project works, which gives perceptual experience and make them to understand different measurements and their conversions.

Patterns:

- Children see patterns all around them both in the man made world and in nature. Encourage children to identify the patterns they see all around them.
- Encourage children not only to identify patterns but also create patterns of their own.
- Encourage children to make number patterns.

Symmetry:

- Encourage children to identify symmetrical objects all around them.
- Encourage children to see symmetry in nature around them.
- Encourage use of mirror in the classroom for understanding line symmetry.

Data handling

- Give children opportunities to collect data in their school and home surroundings and then organize it in different ways i.e., using tables, pictographs and bar charts.

Syllabus

I SPATIAL UNDERSTANDING (16 hrs.)

Shapes and Spatial Understanding

- Identifies 3D shapes in objects (without using the names of the shapes).
- Identifies the edges and corners of 3D shapes.
- Distinguishes among 3 D shapes based on their ability to roll and slide.
- Identifies the side view, top view, front view of simple objects/ plans.
- Identifies the nets of cuboid and cube shaped boxes.
- Identifies 2-D shapes viz., rectangle, square, triangle and circle by their names.
- Identifies 2D shapes in objects.
- Making pictures using known 2D shapes.
- Making shapes on the dotted board.
- Understands the meaning of perimeter and can calculate it.
- Explores line symmetry through reflections, paper cutting, paper folding etc.

Patterns (3 hrs)

- Identifies, carries forward and makes visual patterns.

II NUMBERS (40 hrs.)

Numbers upto 1000

- Using word problems/ contextual situations, reads, writes and compares 2, 3-digit numbers.
- Estimating 2, 3- digit numbers on the number line.
- Understands place value in 2, 3-digit numbers.
- Expands a number using place value.
- Makes numbers using given digits.

Addition and Subtraction

- Using word problems/ contextual situations for additions and subtractions up to 999.(compares and combines different types of word problems).
- Estimates sums and differences of 2, 3 digit numbers.
- Adds and subtracts 2-digit numbers on the empty number line.
- Frames word problems.

Multiplication

- Using word problems/ contextual situations multiplies 1 & 2-digit numbers with 1 & 2-digit numbers using the standard (column) algorithm as well as the distributive law. (Array product - rate product and grouping types of word problems).
- Multiply with 10s and 100s.
- Frames word problems.
- Estimates products- 2×1 , 2×2 , 3×1 .

Division

- Using word problems/ contextual situations dividing 2 & 3-digit numbers by 1 & 2-digit numbers - with remainder and without remainder (using both equal grouping and equal sharing).
- Estimates quotients of 2 & 3-digit numbers divide by 1-digit numbers.
- Frames word problems.
- Explores the relationship between multiplication and division using 2 & 1-digit numbers.

Fractions

- Identifies half, one fourth and three - fourths of a whole.
- Identifies the symbols, $\frac{1}{2}$, $\frac{1}{4}$ and $\frac{3}{4}$.
- Explains the meaning of $\frac{1}{2}$, $\frac{1}{4}$ and $\frac{3}{4}$.
- Compares, adds and subtracts like fractions intuitively.

Patterns (3 hrs)

- Carries forward patters in numbers based on addition, subtraction, multiplication and division.

III Measurement (21 hrs)

Length

- Identifies metre and centimetre lengths.
- Relates metre with centimetre.
- Converts metre into centimetre.
- Measures length in metres, centimetres and inches.
- Estimates length of an object and distance between two given locations.
- Solves problems involving length and distances in metres and centimetres.

Weight

- Understands weight in terms of kilograms and grams using actual weights and created weights.
- Relates kilogram with gram.
- Estimates the weight of an object and verifies it using a balance.
- Solves problems involving weight using kilograms and grams.
- Appreciates the conservation of weight.

Capacity

- Understands capacity in terms of litre and millilitre.
- Relates litre with ml.
- Measures capacity of given liquid using containers marked with standard units.
- Estimates the capacity of a liquid . Verifies by measuring.
- Solves problems involving capacity in litres and millilitres.

Time

- Appreciates the difference in time in terms of minutes, hours, days and months.
- Reads the calendar and identifies the days in the week, the weeks in the month, the months in the year.
- Understands that the year in which February has an extra day is called leap year and that a leap year occurs once in every four years.
- Can relate the date to the day on the calendar.
- Reads clock time to the hours and minutes.
- Solves problems.

IV Data Handling (6 hrs)

- Reading data using a pictograph.
- Reading data using a box chart (bar graph).
- Recording data using tally marks.

Day to day maths (5 hrs) (Money, Length, Weight, Capacity, Space)

- Word problems/ contextual situations using more than one operation and/ or more than one concept and/or multiple stages of solving.
- Estimation in daily life.

Academic Standards

Academic standards are clear statements about what students must know and be able to do. The following are categories on the basis of which we lay down academic standards

The following academic standards should be achieved based on the content of Mathematics

1. Problem Solving

Using concepts and procedures to solve mathematical problems

(a) Kinds of problems

Problems can take various forms- puzzles, word problems, pictorial problems, procedural problems, reading data, tables, graphs etc.

Stages of problem solving

- ◆ Reads problems
- ◆ Identifies all pieces of information/data
- ◆ Separates relevant pieces of information
- ◆ Understanding what concept is involved
- ◆ Selection of procedure
- ◆ Solving the problem

(b) Complexity

The complexity of a problem depends on

- ◆ Making connections(as defined in the connections section)
- ◆ Number of steps in the problem
- ◆ Number of operations in the problem
- ◆ The amount of context unraveling required in the problem
- ◆ Nature of procedures in the problem

2. Reasoning Proof

- ◆ Reasoning between various steps (involves conjuncture invariably).
- ◆ Understanding and making mathematical generalizations and conjectures
- ◆ Understanding and justifying procedures
- ◆ Examining logical arguments.

- ◆ Understanding the notion of proof
- ◆ Using inductive and deductive logic
- ◆ Testing mathematical conjectures

3. Communication

- ◆ Writing and reading mathematical expressions like

Ex: $3 + 4 = 7$

$$\frac{3}{4}$$

$3 \times 5 = ?$

- ◆ Creating mathematical expressions
- ◆ Explaining mathematical ideas in his/her own words like- a square is closed figure having four equal sides and all equal angles
- ◆ Explaining mathematical procedures like- adding two digit numbers involves first adding the digits in the units place and then adding the digits at the tens place/ keeping in mind carry over.
- ◆ Explaining mathematical logic

4. Connections

- ◆ Connecting concepts within a mathematical domain- for example relating adding to multiplication, parts of a whole to a ratio, to division. Patterns and symmetry, measurements and space
- ◆ Making connections with daily life
- ◆ Connecting mathematics to different subjects
- ◆ Connecting concepts of different mathematical domains like data handling and arithmetic or arithmetic and space
- ◆ Connecting concepts to multiple procedures

5. Visualization and Representation

- ◆ Interprets and reads data in a table, number line, pictograph, bar graph, 2-D figures, 3-D figures, pictures
- ◆ Making tables, number line, pictograph, bar graph, pictures

LEARNING OUTCOMES

MATHEMATICS

CLASS 4

The learner....

- Reads and writes numerals for numbers greater than 1000 and compares the numbers by using place values of the digits in a number.
- Solves simple real life situation problems by using four fundamental operations
- Identifies half, one-fourth and three-fourths in a group of objects or an object and represents it in a given picture.
- Identifies edges, corners and faces of 3D objects and counts them. Prepares net shapes of 3D objects
- Identifies 2D shapes like triangle, rectangle, square and circle by counting sides and corners.
- Estimates the length or distance in centimeter and meter; weight in gram and kilogram; capacity in liters and milliliters. Verifies by measuring them
- Reads the time correctly to the hour and minutes using a clock. Reads the calendar and writes the date in correct format.
- Calculates the perimeter of a geometrical figure formed by line segments.
- Extends and creates patterns in simple shapes and numbers.
- Represents data in a tabular and pictorial form and draws conclusions.



ಕರ್ನಾಟಕ ಸರ್ಕಾರ
ಶಿಕ್ಷಣ ಮತ್ತು ಸಂಶೋಧನೆ



TEXTBOOK DEVELOPMENT COMMITTEE MEMBERS

WRITERS

- Sri. Ch. Keshava Reddy**, SGT, PS Motla Palli, Srirampur Mandal, Karimnagar District.
Sri. A. Saidi Reddy, SGT, PS Zaphi Veerappa Gudem, Miryalaguda Mandal, Nalgonda District.
Sri. Ch. Keshav, SGT, UPS Vattipally, Marriguda Mandal, Nalgonda District.
Sri. T. Suresh, SGT, UPS Lingampet, Jagityal Mandal, Karimnagar District.
Sri. Marrapu Srinivasa rao, SGT, PS Y. Sembi, Salur Mandal, Vizianagaram District.
Sri. S. Dharmender Singh, SA, UPS Ponna, Ichoda Mandal, Adilabad District.
Sri. Nagula Ravi Goud, SA, Z.P.H.S. Lokeshwaram, Lokeshwaram Mandal, Adilabad District.
Sri. K. Sreedhara Charyulu, SA, Z.P.H.S. Rangayyapally, Medak District.
Sri. K. Ramaiah, SA, Z.P.S.S. Kasimdevpet, Mulugu Mandal, Warangal District.
Sri. Khaja Bande Nawaz, SA, Z.P.H.S. Kalugotla, Kurnool District.
Sri. S. Rajashekar Reddy, SA, Z.P.H.S. Medivemula, Kurnool District.
Sri. K. Nageshwar Rao, HM, G.H.S.Peravalli, West Godavari District.
Sri.T. Sairamakrishna, HM, BFMHS Samalkot, East Godavari District.
Sri.M. Ramanjaneyulu, Lecturer, DIET Vikarabad, Ranga Reddy District.

WRITER & COORDINATOR

- Sri.Kakulavaram Rajender Reddy**, Coordinator, Mathematics Textbooks, S.C.E.R.T., Hyderabad.

EDITORS

- Dr. S. Suresh Babu**, Professor, SCERT, Hyderabad.
Sri.K. Brahmaiah, Retd. Professor, SCERT, Hyderabad.
Sri.B. Harisarvothama Rao, Retd. Lecturer, SCERT, Hyderabad.

CHAIR PERSON FOR POSITION PAPER AND MATHS CURRICULUM AND TEXT BOOK DEVELOPMENT

- Prof.V. Kannan**, Department of Mathematics & Statistics, University of Hyderabad.

CHIEF ADVISORS

Sri Chukka Ramaiah,
Educationist,
Andhra Pradesh, Hyderabad.

Dr. H.K. Dewan,
Education Advisor, Vidya Bhawan Society
Resource Centre, Udaipur, Rajasthan.

ACADEMIC SUPPORT GROUP MEMBERS

- Smt. Padma Priya Shirali**, Community Mathematic Centre, Rishi Vally School, Chittoor District.
Smt. Namirta Batra, Vidya Bhawan Society, Resource Centre, Udaipur, Rajasthan.
Kumari Varsha Gupta, Vidya Bhawan Society, Resource Centre, Udaipur, Rajasthan.
Ms. Preeti Mishra, Vidya Bhawan Society, Resource Centre, Udaipur, Rajasthan.
Sri. Sharan Gopal, Dept. of Mathematics & Statistics, University of Hyderabad.

ILLUSTRATIONS AND DESIGN TEAM

- Sri. Prashanth Soni**, Vidya Bhawan Society, Resource Centre, Udaipur, Rajasthan.
Sri. Bhawani Shankar, Vidya Bhawan Society, Resource Centre, Udaipur, Rajasthan.
Sri. Kailash Yadav, Vidya Bhawan Society, Resource Centre, Udaipur, Rajasthan.

TEXTBOOK DEVELOPMENT & PUBLISHING COMMITTEE

- Chief Production Officer : **Sri. A. Satyanarayana Reddy,**
Director, SCERT, Hyderabad.
- Executive Chief Organiser : **Sri.B. Sudhakar,**
Director, Govt. Text Book Press, Hyderabad.
- Organising Incharge : **Dr. Nannuru Upender Reddy,**
Prof. & Head, Curriculum & Text Book Department,
SCERT, Hyderabad.

QR CODE TEAM

